

UK

PLEASE LEAVE THIS INSTRUCTION
WITH THE USER

MURELLE EV HE 25/55 - 30/55

*Installation and
servicing instructions*



SAFE HANDLING

This boiler may require 2 or more operatives to move it into its installation site, remove it from its packaging and during movement into its installation location. Manoeuvring the boiler may include the use of a sack truck and involve lifting pushing and pulling.

Caution should be exercised during these operations.

Operatives should be knowledgeable in handling techniques when performing these tasks and the following precautions should be considered:

- Grip the boiler at the base
- Be physically capable
- Use personal protective equipment as appropriate e.g. gloves, safety footwear.

During all manoeuvres and handling actions, every attempt should be made to ensure the following unless unavoidable and/or the weight is light.

- Keep back straight
- Avoid twisting at the waist
- Always grip with the palm of the hand
- Keep load as close to the body as possible
- Always use assistance

WARNING

Caution should be exercised when performing any work on this appliance.

Protective gloves and safety glasses are recommended.

- Avoid direct contact with sharp edges.
- Avoid contact with any hot surfaces.

NOTICE

Please be aware that due to the wet testing of the appliance, there may be some residual water in the hydraulic circuit.

- Protect any surfaces, carpets or floorings.
- Use a suitable container to catch any water that escapes when removing the protective caps from the connections.

Code Of Practice

For the installation, commissioning and servicing
of domestic heating and hot water products

Benchmark places responsibilities on both manufacturers and installers.* The purpose is to ensure that customers** are provided with the correct equipment for their needs, that it is installed, commissioned and serviced in accordance with the manufacturer's instructions by competent persons and that it meets the requirements of the appropriate Building Regulations. Installers are required to carry out work in accordance with the following:

Standards of Work

- Be competent and qualified to undertake the work required.
- Install, commission, service and use products in accordance with the manufacturer's instructions provided.
- Ensure that where there is responsibility for design work, the installation is correctly sized and fit for purpose.
- Meet the requirements of the appropriate Building Regulations. Where this involves notifiable work be a member of a Competent Persons Scheme or confirm that the customer has notified Local Authority Building Control (LABC), prior to work commencing.
- Complete all relevant sections of the Benchmark Checklist/Service Record when carrying out commissioning or servicing of a product or system.
- Ensure that the product or system is left in a safe condition and, whenever possible, in good working order.
- Highlight to the customer any remedial or improvement work identified during the course of commissioning or servicing work.
- Refer to the manufacturer's helpline where assistance is needed.
- Report product faults and concerns to the manufacturer in a timely manner.

Customer Service

- Show the customer any identity card that is relevant to the work being carried out prior to commencement or on request.
- Give a full and clear explanation/demonstration of the product or system and its operation to the customer.
- Hand over the manufacturer's instructions, including the Benchmark Checklist, to the customer on completion of an installation.
- Obtain the customer's signature, on the Benchmark Checklist, to confirm satisfactory demonstration and receipt of manufacturer's instructions.
- Advise the customer that regular product servicing is needed, in line with manufacturers' recommendations, to ensure that safety and efficiency is maintained.
- Respond promptly to calls from a customer following completion of work, providing advice and assistance by phone and, if necessary, visiting the customer.
- Rectify any installation problems at no cost to the customer during the installer's guarantee period.



*The use of the word "installer" is not limited to installation itself and covers those carrying out installation, commissioning and/or servicing of heating and hot water products, or the use of supporting products (such as water treatment or test equipment).

**Customer includes householders, landlords and tenants.

The Benchmark Scheme

Sime Ltd is a licensed member of the Benchmark Scheme which aims to improve the standards of installation and commissioning of domestic heating and hot water systems in the UK and to encourage regular servicing to optimise safety, efficiency and performance.

Benchmark is managed and promoted by the Heating and Hotwater Industry Council.
For more information visit www.centralheating.co.uk



Murelle EV HE 25/55: Gas Council number 47-283-20

Murelle EV HE 30/55: Gas Council number 47-283-21

CONTENTS

1	DESCRIPTION OF THE BOILER	pag.	6
2	INSTALLATION	pag.	10
3	CHARACTERISTICS	pag.	22
4	USE COMMISSIONING, AND MAINTENANCE (including BENCHMARK/Mains Pressure Hot Water Storage Checklist & Service Record)	pag.	27
5	FAULT FINDING	pag.	37
6	REPLACEMENT OF PARTS	pag.	38
7	EXPLODED VIEWS	pag.	40

Important Information

IT IS A STATUTORY REQUIREMENT THAT ALL GAS APPLIANCES ARE INSTALLED BY COMPETENT PERSONS, IN ACCORDANCE WITH THE GAS SAFETY (INSTALLATION AND USE) REGULATIONS (CURRENT EDITION). The manufacturer's instructions must not be taken as overriding any statutory requirements, and failure to comply with these regulations may lead to prosecution.

No modifications to the appliance should be made unless they are fully approved by the manufacturer.

GAS LEAKS: DO NOT OPERATE ANY ELECTRICAL SWITCH, OR USE A NAKED FLAME. TURN OFF THE GAS SUPPLY AND VENTILATE THE AREA BY OPENING DOORS AND WINDOWS CONTACT THE GAS EMERGENCY SERVICE ON 0800111999.



Please refer to commissioning instructions for filling in the checklist of this installation guide.

Note: All Gas Safe registered installers carry a ID Card.

You can check your installer is Gas Safe Registered by calling 0800 408 5577

IMPORTANT

When carrying out commissioning of the boiler, you are highly recommended to perform the following checks:

- Make sure that there are no liquids or inflammable materials in the immediate vicinity of the boiler.
- Make sure that the electrical connections have been made correctly and that the earth wire is connected to a good earthing system.
- Open the gas tap and check the soundness of the connections, including that of the burner.
- Make sure that the boiler is set for operation for the type of gas supplied.
- Check that the flue pipe for the outlet of the products of the combustion is unobstructed and has been properly installed.
- Make sure that any shutoff valves are open.
- Make sure that the system is charged with water and is thoroughly vented.
- Check that the circulating pump is not jammed (CAUTION: protect the control panel from any water lost from the pump).
- Purge the system, bleeding off the air present in the gas pipe by operating the pressure relief valve on the gas valve inlet.
- Ensure that all the controls and safety devices have been demonstrated to the user.
- Ensure that all the manuals and documentation that are supplied with the boiler are left with the user.

1 DESCRIPTION OF THE BOILER

1.1 INTRODUCTION

MURELLE EV HE 25-30/55 are premixed gas condensation thermal modules that employ a microprocessor-based technology to control and manage all the functions. All modules are compliant with European Directives 2009/142/CE, 2004/108/CE, 2006/95/CE and 92/42/CE. For optimum installation and operation, always follow the instructions provided in this manual.

The products manufactured and sold by Sime do not contain any banned materials or substances (ie they comply with ISO9000:2000).

1.2 UNPACK AND CHECK THE CONTENTS, AND PACKAGING REMOVAL.

1.2.1 Handling the boiler

Due to the weight of the boiler, take care to avoid personal injury or damage.

1.2.2 Storage Prior to installation

The boiler must be stored horizontally on its pallet prior to installation. Do not stack more than six units.

1.2.3 Unpacking the boiler

The boiler is supplied fully assembled, the kit includes :

- boiler
- valve pack
- guarantee
- these Installation/Users instructions
- wall mounting template.

Remove the strapping and carefully remove the carton and packaging.

Check the contents, instructions, valve pack, and hanging bracket.

Remove the two bolts securing the boiler to the pallet.

1.3 DIMENSIONS

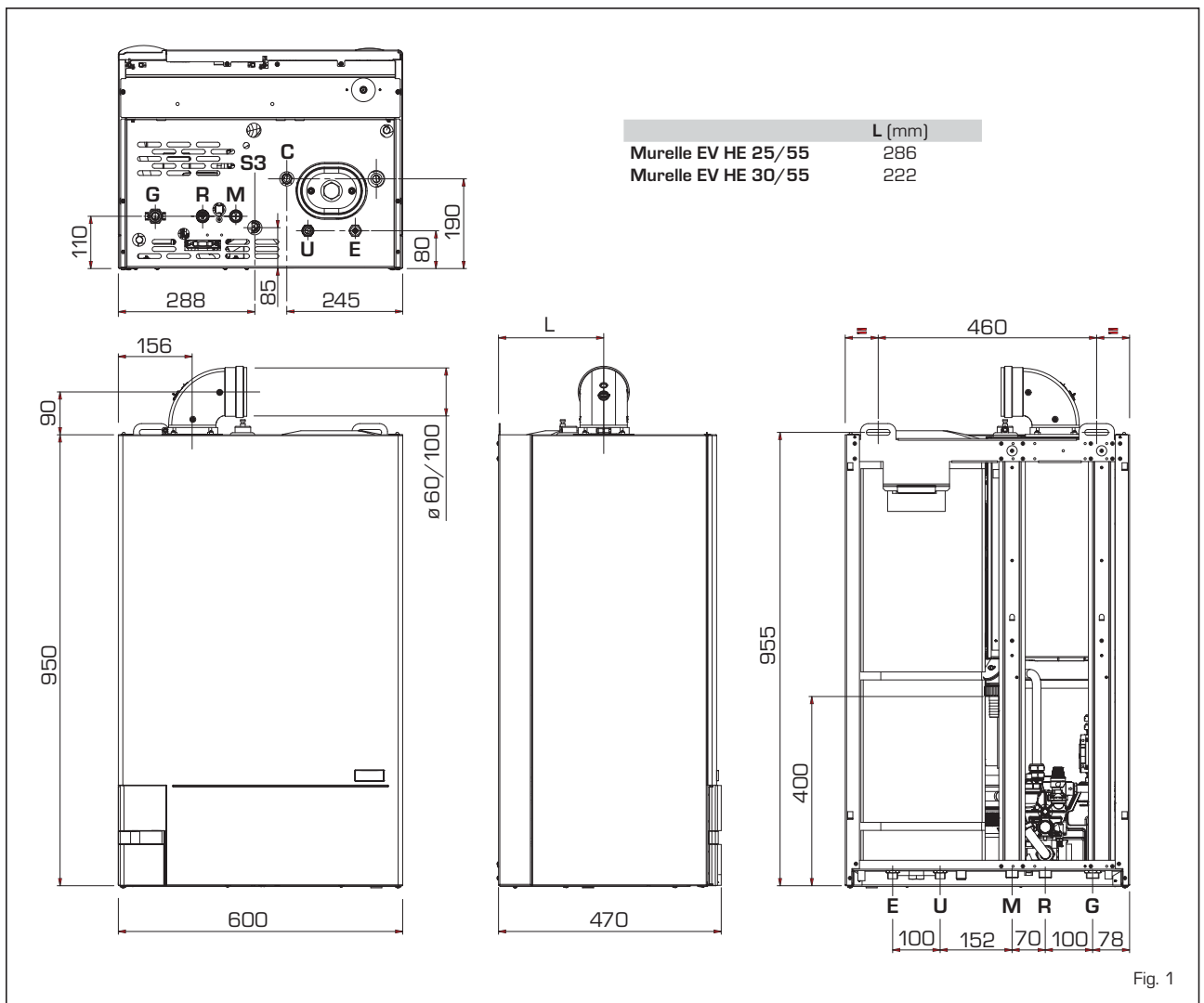

CONNECTIONS

R	C.H. return	22 mm	Compression
M	C.H. flow	22 mm	Compression
G	Gas connection	15 mm	Compression
E	D.H.W. inlet	22 mm	Compression
U	D.H.W. outlet	15 mm	Compression
C	Ricirculation	15 mm	Compression
S3	Condensation outlet \varnothing 20		

SERVICE CLEARANCES

ABOVE THE APPLIANCE CASING	300 mm
AT THE R.H.S.	20 mm
AT THE L.H.S.	20 mm
BELOW THE APPLIANCE CASING	400 mm
IN FRONT OF THE APPLIANCE	500 mm

1.4 TECHNICAL FEATURES

Models		25/55	30/55
Heat output			
Nominal (80-60°C)	kW	23.9	28.9
Nominal (50-30°C)	kW	26.2	31.6
Reduced G20 (80-60°C)	kW	6.1	7.6
Reduced G20 (50-30°C)	kW	7.0	8.5
Reduced G31 (80-60°C)	kW	7.5	8.7
Reduced G31 (50-30°C)	kW	8.5	9.6
Heat input			
Nominal	kW	24.5	29.5
Reduced G20/G31	kW	6.5/8.0	8.0/9.0
Max/min useful yield (80-60°C)	%	94/97.5	95/98
Max/min useful yield (50-30°C)	%	107/107	107/107
Useful yield at 30% of the load (50-30°C)	%	107	107
Thermal efficiency (CEE 92/42 directive)		★★★★	★★★★
Losses after shutdown to 50°C (EN 483)	W/h	90	95
Supply voltage	V-Hz	230-50	230-50
Adsorbed power consumption	W	115	115
Electrical protection grade	IP	X4D	X4D
C.H. setting range	°C	20/80	20/80
Water content boiler	l	9.6	10
Maximum water head	bar	3	3
Maximum temperature	°C	85	85
Capacity/pressure of the heating expansion vessel	l/bar	10/1	10/1
Normal operating pressure of the system (max)	bar	5.5	5.5
D.H.W. setting range	°C	30/60	30/60
D.H.W. flow rate (EN 625)	l/min	15.5	17.5
Continuous D.H.W. flow rate Δt 30°C	l/min	11.4	13.8
Continuous D.H.W. flow rate Δt 35°C	l/min	9.8	11.8
D.H.W. pressure min/max	bar	0.2/5.5	0.2/5.5
D.H.W. tank capacity	l	51	51
Recuperation time between 15 and 60°C	min	9' 55"	10' 10"
Recuperation heat of 70% contents	min	3' 40"	3' 30"
D.H.W. expansion vessel capacity / charge pressure	l/bar	2.5/3.0	2.5/3.0
Exhaust fumes temperature at max flow rate (80-60°C)	°C	70	70
Exhaust fumes temperature at min. flow rate (80-60°C)	°C	65	65
Exhaust fumes temperature at max flow rate (50-30°C)	°C	40	40
Exhaust fumes temperature at min. flow rate (50-30°C)	°C	35	35
Smokes flow min/max	kg/h	12/42	14/50
CO₂ at max/min flow rate G20 - G31	%	9.0/9.0 - 10.0/10.0	9.0/9.0 - 10.0/10.0
CE certification	n°	1312BS5039	1312BS5039
Category		II2H3P	II2H3P
Type		B23P-53P/C13-33-43-53-83	B23P-53P/C13-33-43-53-83
NO_x emission class		5 (< 70 mg/kWh)	5 (< 70 mg/kWh)
Weight when empty	kg	68	70
Main burner nozzle			
Quantity nozzles	n°	1	1
G20/G31 nozzle diameter	∅	6.0/4.4	6.0/4.4
Consumption at maximum/minimum flow rate			
G20	m ³ /h	2.59/0.53	3.12/0.66
G31	kg/h	1.90/0.62	2.29/0.62
Gas supply pressure			
G20/G31	mbar	20/37	20/37

1.5 FUNCTIONAL DIAGRAM

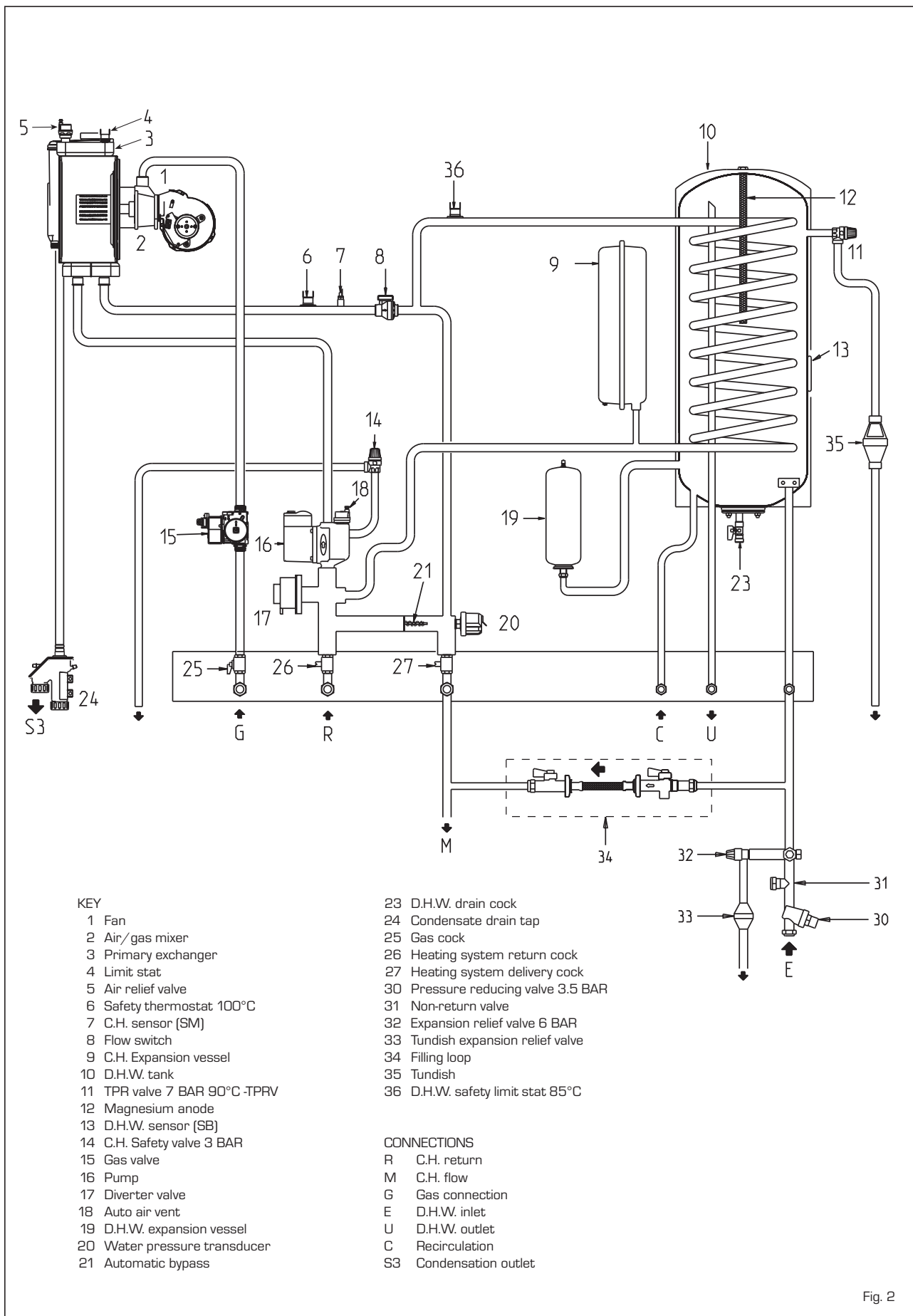
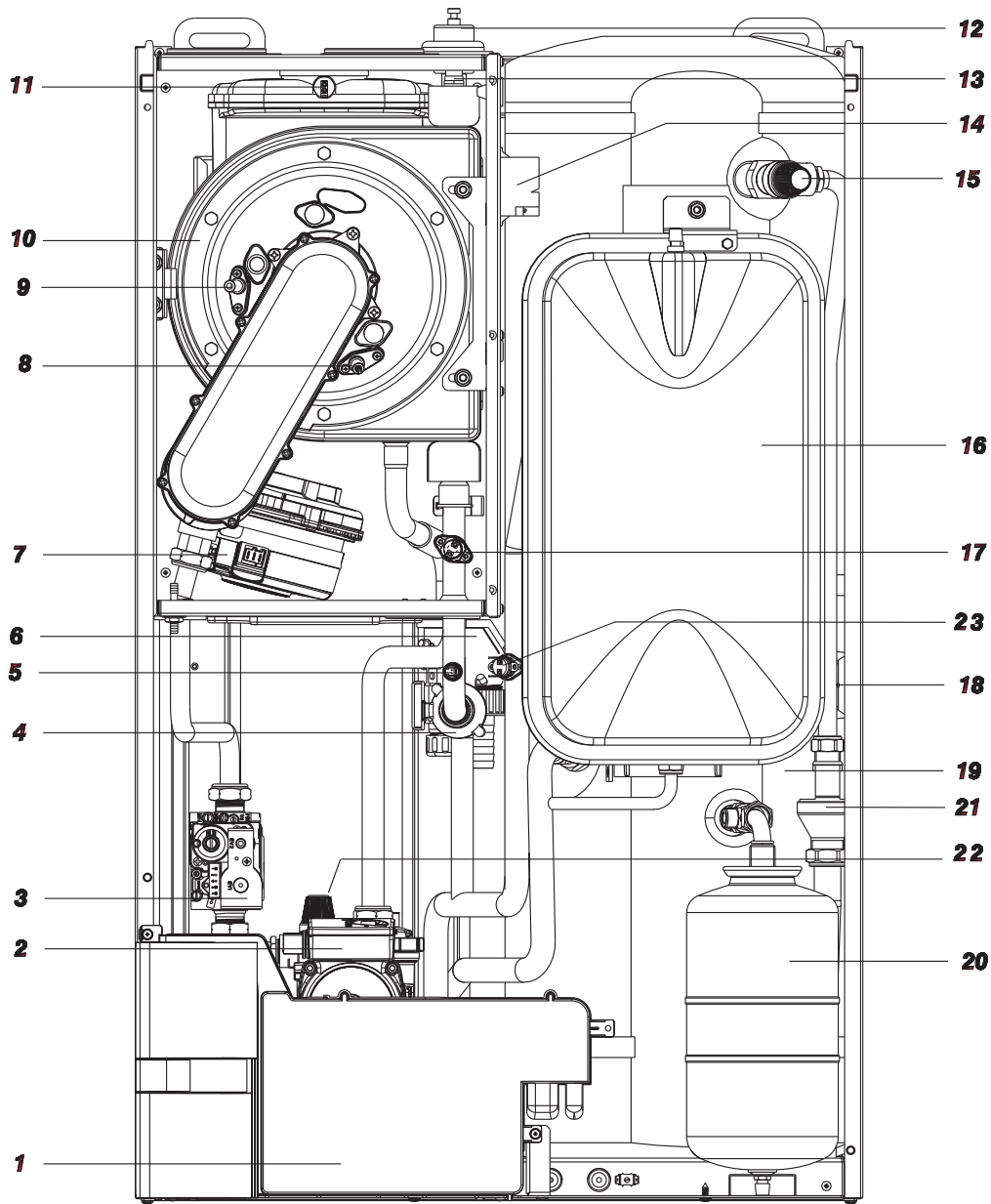

Fig. 2

1.6 MAIN COMPONENTS



KEY

- | | |
|------------------------------|--|
| 1 Control panel | 13 Limit stat 90°C |
| 2 Pump | 14 Ignition transformer |
| 3 Gas valve | 15 D.H.W. combined temperature and pressure relief valve |
| 4 Flow switch | 16 Expansion vessel |
| 5 C.H. sensor (SM) | 17 Safety thermostat 100°C |
| 6 Condensate drain tap | 18 D.H.W. sensor (SB) |
| 7 Fan | 19 D.H.W. tank |
| 8 Ionisation electrode | 20 D.H.W. expansion vessel |
| 9 Ignition electrode | 21 Tundish |
| 10 Primary heat exchanger | 22 C.H. safety valve 3 BAR |
| 11 Exhaust fumes sensor (SF) | 23 D.H.W. safety limit stat 85°C |
| 12 Auto air vent | |

Fig. 3

2 INSTALLATION

Where no specific instructions are given, the installation should be in accordance with the relevant recommendations in the current editions of the following British Standards and Codes of Practice: BS 5440-1, BS 5440-2, BS 5449, BS 5482 (propane installations), BS 5546, BS 6700, BS 6798, BS 6891, Institute of Gas Engineer document IGE/UP-7, BS 7074 (expansion vessel), and to other relevant British Standards or code of Practice as necessary. It is a **Statutory Requirement** that the installation conforms to the appropriate Building Regulations either The Building Regulations, The Building Regulations (Scotland), Building Regulations (Northern Ireland), the Water Fitting Regulations or Water Byelaws in Scotland, and the current I.E.E Wiring Regulations. When handling, due consideration should be given to the appliance weight. If the appliance is not to be installed immediately it should be stored in a clean dry place.

2.1 VENTILATION REQUIREMENTS

Detailed recommendations for air supply are given in BS5440:2. The following notes are for general guidance:

- It is not necessary to have a purpose provided air vent in the room or compartment in which the appliance is installed. However, suitable clearances for maintenance and servicing should be provided, see fig. 1.

2.1.1 Anti-freeze function

The boilers are equipped with anti-freeze function which activates the pump and the burner when the temperature of the water contained inside the appliance drops to below 6°C. The anti-freeze function is ensured, however, only if:

- the boiler is correctly connected to the gas and electricity supply circuits;
- the boiler is turned on;
- the boiler ignition is not locked out;
- the essential components of the boiler are all in working order.

In these conditions the boiler is protected against frost down to an environmental temperature of -5°C.

ATTENTION: In the case of installation in a place where the temperature drops below 0°C, the connection pipes must be protected.

2.2 BOILER SUPPORT BRACKET

Ensure that the wall on which the boiler is to be mounted is capable of supporting the weight of the boiler when filled (123 kg - 25/55 and 125 kg - 30/55)

- Position the bracket ensuring that the boiler is fitted with sufficient clearance to allow for the fitting of the valve connec-

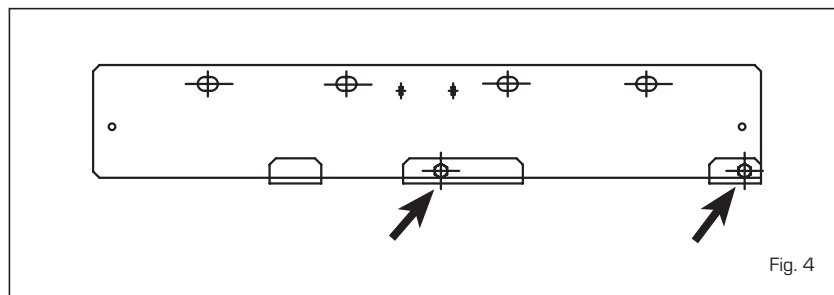

tions.

- Fix the bracket level and with fixings capable of supporting the weight.
- Hang the boiler and then tighten the screws indicated in fig. 4.

2.3 HOW TO FIT C.H. AND D.H.W. FITTINGS AND GAS COCK (fig. 5)

- C.H. CONNECTIONS (R & M)

Fit the two isolation valves (10) using the gasket supplied (6). Fit the C.H. filling loop between the C.H. and D.H.W. circuits, ensuring the correct position and orientation of the isolation valves.

- D.H.W. CONNECTION (E & U)

Fit the supplied; pressure reducing valve (17), check valve (16), and expansion relief valve assembly (14) with its associated tundish (15), ensure that on completion of the installation that the tundish is visible to the user, in the D.H.W. supply to the appliance, the flow from this assembly should be connected to the cold water inlet (E) via the flow regulator housing supplied. Ensure flow regulator (11) and gasket (1) supplied, are fitted in the flow regulator housing.

See fig. 5 and fig. 6 for installation details. It is important that no isolating valve is fitted between the expansion relief valve and the inlet to the D.H.W. tank. Any additional D.H.W. drain down tap fitted should be positioned as low as possible to ensure that at least 80% of the D.H.W. tank's capacity can be drained.

If installed in a Hard Water area, then a suitable device should be fitted to treat the mains supply to the appliance (Contact your Water Distribution Company for advice on suitable devices). Fit the quarter bend (2) to the hot water outlet (U) using the gasket supplied (1).

- GAS CONNECTION (C)

Fit the gas cock (12) to the gas connection (R) using the gasket supplied (6).

2.4 WATER SYSTEMS - GENERAL

This appliance is designed for connection to sealed central heating water systems. Check that the mains water flow is sufficient to produce the required DHW flow rate but

does not exceed 4 bar pressure.

A expansion relief valve is incorporated within the valve kit. Inlet safety kit and all safety devices must be installed.

For balanced pressures in premises

For balanced pressure to the whole premises an additional pressure reducing valve should be installed at the inlet to the premises set at 3.5 BAR.

The maximum water supply pressures to the pressure reducing must be no more than 16 BAR.

2.4.1 Treatment of Water Circulating Systems

- All recirculatory systems will be subject to corrosion unless an appropriate water treatment is applied. This means that the efficiency of the system will deteriorate as corrosion sludge accumulates within the system, risking damage to pump and valves, boiler noise and circulation problems.

- For optimum performance after installation this boiler and its associated central heating system must be flushed in accordance with the guidelines given in BS 7593 "Treatment of water in domestic hot water central heating systems".

- Sime Ltd recommend only the use of FERNOX products for the flushing and final treatment of the system water. This is particularly important in hard water areas. Artificially softened water must not be used to fill the heating system.

Failure to flush and add inhibitor to the system may invalidate the appliance warranty.

- It is important to check the inhibitor concentration after installation, system modification and at every service in accordance with the manufacturer's instructions.

(Test kits are available from inhibitor stockists).

2.4.2 Requirements for sealed water systems

The heating system design should be based on the following information:

- a) The available pump head is given in fig.

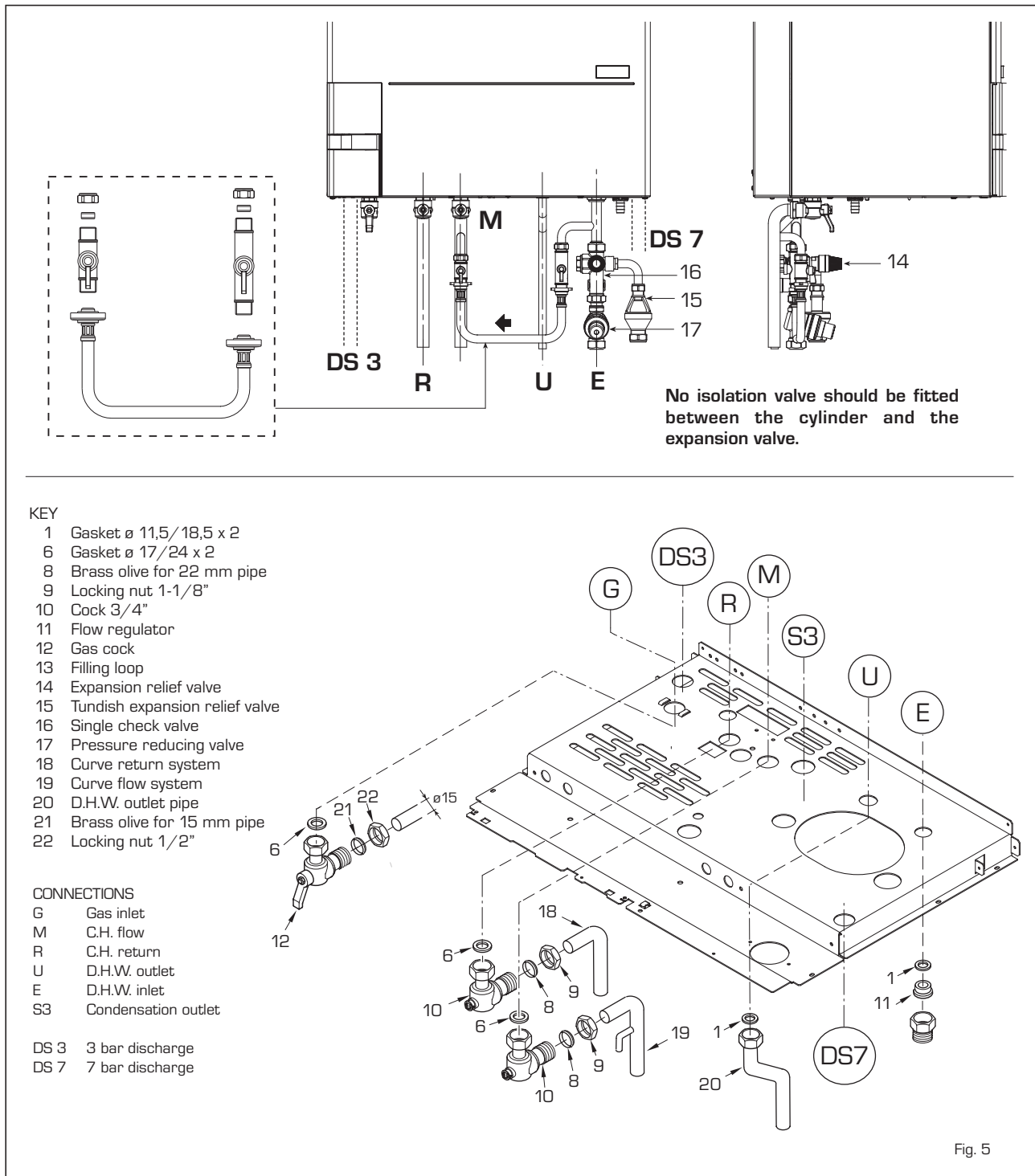

Fig. 5

- 20.
- b) The burner starts when the C.H. flow reaches 400÷450 l/h. This safety condition is ensured by the flow switch.
- c) The appliance is equipped with an internal by-pass that operates with system heads (H) greater than 3 m. The maximum flow through the by-pass is about 300 l/h. If thermostatic radiator valves are to be installed, at least one radiator should be without a thermostatic valve (usually the bathroom radiator).

d) A sealed system must only be filled by a competent person using the filling loop as shown in fig 5.

e) To fill the cylinder, open a DHW tap, then turn on the domestic water supply. When water runs from the tap turn it off. Repeat at each DHW tap.

NOTE: there should be no isolation valve fitted between the cylinder and the expansion valve.

f) To drain the cylinder see fig. 2 number 23.

2.4.3 Discharge Pipes and fittings

The position of any tundish must be visible to the occupants and any tundish, drain valve and discharge pipe and must be sited away from any electrical components. The 7 and 3 bar PRV's are called out with the number 15 and 22 on fig. 3. The connections to the expansion relief valve and temperature and pressure relief valve should not be used for any other purpose. See fig. 6 for example of the discharge pipe(s) for the temperature and pressure relief valve, and expansion relief valve terminations.

Note: it is permitted to connect discharge pipes together provided that the joint pipe is sized to accommodate the combined flow.

2.4.4 Expansion Vessel (C.H. only)

C.H. EXPANSION VESSEL – The integral expansion vessel is pre-charged to a pressure of 1.0 bar, which should be checked before the C.H. water system is filled. This vessel is suitable for correct operation of system capacities up to 82 litre capacity. If the actual C.H. system volume is greater, then an additional vessel must be fitted to the system. For systems where the volume is greater, the additional expansion vessel volume can be determined by multiplying the volume in excess of that which can be accommodated by the appliance by the factor 0.901. BS 7074 gives further details regarding C.H. expansion vessel sizing.

2.4.5 Connection of condensation water trap

The drip board and its water trap must be connected to a civil drain through a pipe with a slope of at least 5 mm per metre to ensure drainage of condensation water.

The plastic pipes normally used for civil drains are the only type of pipe which is appropriate for conveying condensation to the building's sewer pipes.

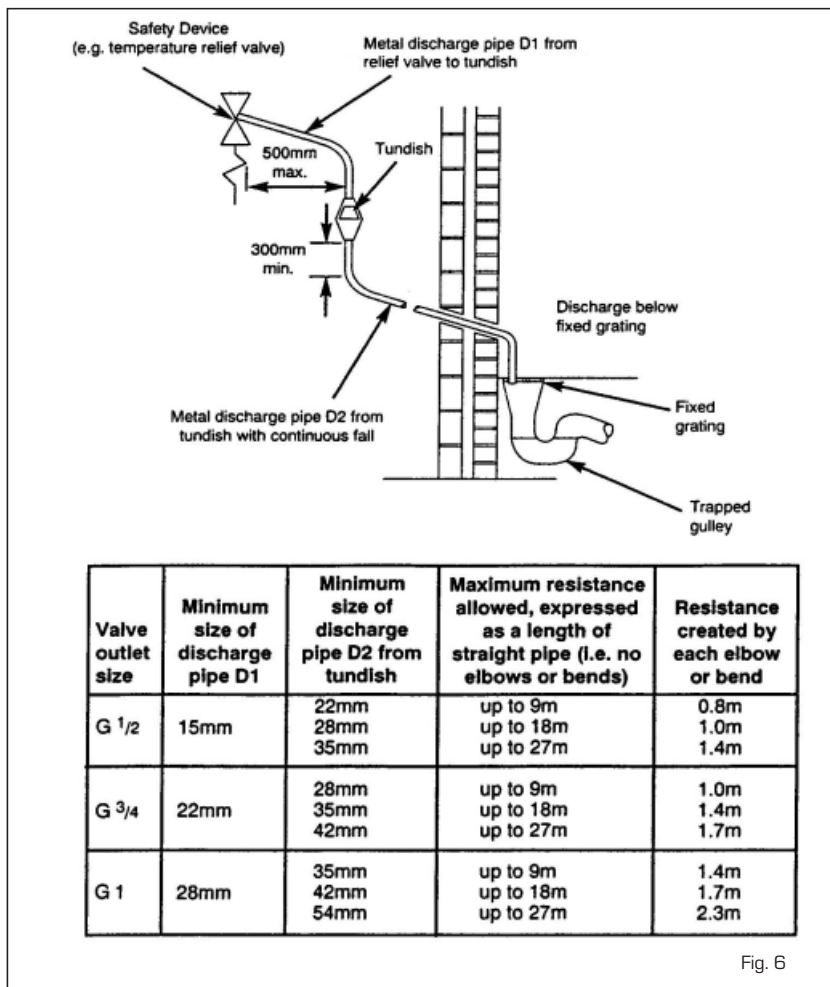

Fig. 6

IMPORTANT:

- The insertion of each additional 90° bend with a diameter of 60/100 (code 8095850) reduces the available section by 1.5 meters.
- The insertion of each additional 90° bend with a diameter of 80/125 (code 8095870) reduces the available section by 2 meters.
- Each additional 45° curve installed a diameter of 60/100 (code 8095950) the 80/125 (code 8095970) reduces the available length by 1.0 metres.
- During assembly it is important to make sure that the kit with axial pipes [1] is positioned **HORIZONTAL FLUES MUST BE LEVEL..**

NOTE: Before connecting accessories, it is always advisable to lubricate the internal part of the gaskets with silicon products. Avoid using oils and greases.

Model	Length of pipe ø 60/100			Length of pipe ø 80/125		
	H	V		H	V	
		Min	Max		Min	Max
25/55	6 m	1.3 m	8 m	12 m	1.2 m	15 m
30/55	5 m	1.3 m	7 m	10 m	1.2 m	13 m

LIST OF ø 60/100 ACCESSORIES

- 1a-b Coaxial duct kit L. 790 code 8096250
- 2a Extension L. 1000 code 8096150
- 2b Extension L. 500 code 8096151
- 3 Vertical adaptor code 8086950

LIST OF ø 80/125 ACCESSORIES

- 1a-b Coaxial duct kit L. 785 code 8096253
- 2a Extension L. 1000 code 8096171
- 2b Extension L. 500 code 8096170
- 3 Adapter for ø 80/125 code 8093150
- 5 Articulated tile 8091300
- 6 Roof Terminal 8091205

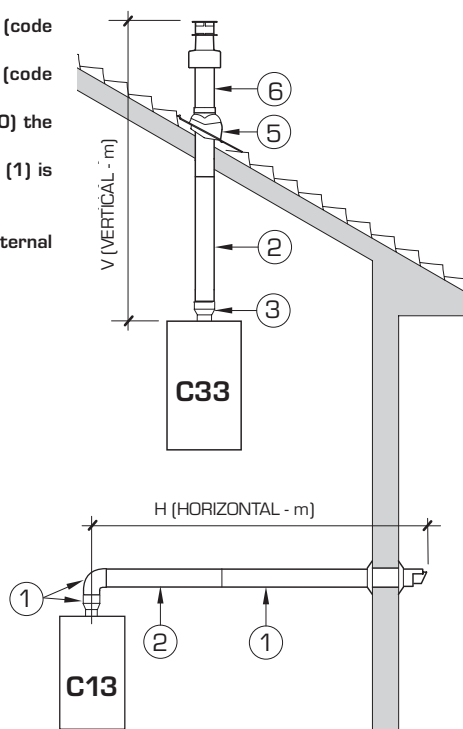

Fig. 7

2.4.6 Dealing with condensate (fig.6/a)

Five suitable drainage points

Five suitable drainage points:

1. Internal drain stack pipe
2. Waste water pipe*
3. External drain or gully*
4. Rainwater hoppers that carry both rain water and foul water*
5. Purpose-made soakaways

* Care should be taken not to contaminate any "Grey Water Systems"

Pipework

Condensate pipework should be plastic, same as used for standard wastewater plumbing.

Similarly the drainage system where the condensate discharges to should also be resistant to the acid condensate.

Pipework should be kept as short as possible. External runs should be avoided, but when necessary be a minimum of 3 meter in 32 mm diameter pipework and lagged to avoid freezing, this also applies to pipe runs in unheated areas such as garages.

To reduce the possibility of condensate being trapped in the pipe, the number of bends should be kept to a minimum. Pipework must be angled down from the boiler with a fall of at least 2.5°.

The pipework must be supported at a distance of 0.5 m for inclined runs and 1.0 m for vertical runs.

Condensate traps

Where the condensate drain is not sealed to the discharge connection a trap will be required. The water seal should be 38 mm or more for external discharge and 75 mm or more for internal discharge. When connecting to a external stack the trap should be located within the building.

Stack pipes

Condensate connections should be at least 450 mm above any bend at the bottom of a stack pipe in a single or multi-story dwelling up to 3 storeys. There are specific requirements when connecting to a stack pipe serving multi-storey buildings greater than 3 storeys.

All connections to stack pipes should avoid

across flow between other Branch pipes.

Soakaways

Any soakaways have to be purpose-made and located as close to the boiler as possible, but clear of the buildings foundations and any buried services. The best option is to purchase a soakaway from a drainage manufacturer and install it to the manufacturers recommendation.

Condensate disposal positioning and termination of the condensate drain pipe

The condensate pipe should run and terminate internally to the house soil and vent stack or waste pipe. Alternatively, the condensate can be discharged into the rainwater system, or into a purpose-made soak away (condensate absorption point).

An alternative condensate waste pipe should be considered where the system could be effected by extreme weather conditions.

All connecting drainage pipework should have a fall of at least 2.5° to the horizontal, or approximately 50 mm per metre of pipe run.

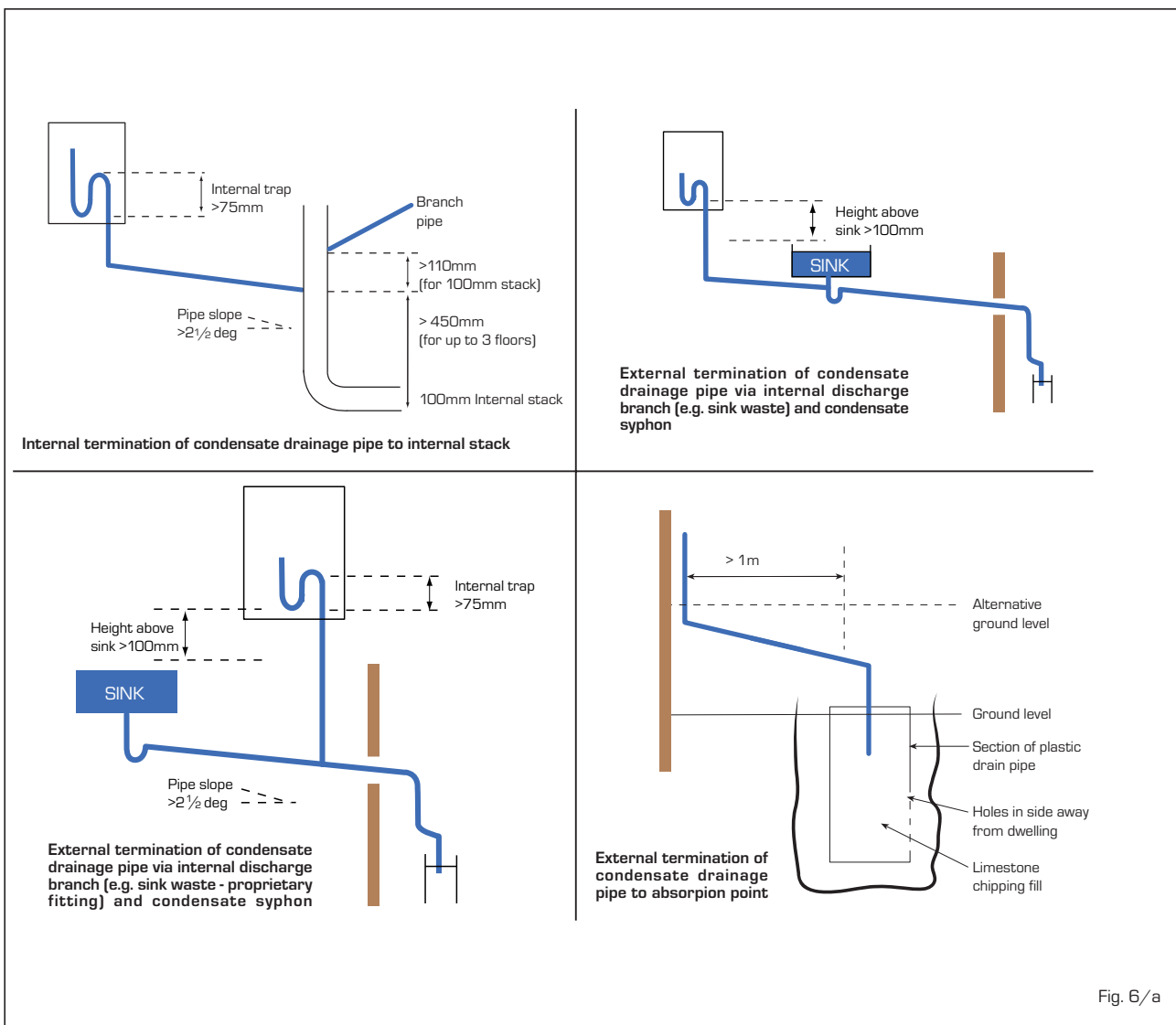

Fig. 6/a

2.4.7 Filter on the gas pipe

The gas valve is supplied ex factory with an inlet filter, which, however, is not adequate to entrap all the impurities in the gas or in gas main pipes.

To prevent malfunctioning of the valve, or in certain cases even to cut out the safety device with which the valve is equipped, install an adequate filter on the gas pipe.

2.4.8 Discharge Pipe

See fig. 6 for example discharge pipe terminations.

2.5 INSTALLATION OF COAXIAL DUCT (ø 60/100 - ø 80/125)

The axial suction and discharge pipes are supplied in a special kit (that can be purchased separately) along with assembly instructions. The diagrams of fig. 7 illustrate some examples of different types of discharge modalities allowed and the maximum lengths that can be reached.

2.6 INSTALLATION OF SEPARATE DUCTS (ø 80)

Separate duct kit code 8089911 is used to

connect twin 80mm pipes. See fig 8. The maximum overall length of the flue is determined by the head losses of the individual components and must not exceed 15mm H₂O. Additionally the length of either the inlet or exhaust pipe must not exceed 50 m. See **Table 1** for information on the load losses of single accessories and **Fig. 9** for types of "smoke outlet"- "air inlet".

2.6.1 Separate ducts kit

The diagrams of Figure 9 show a few examples of the permitted exhausts configurations.

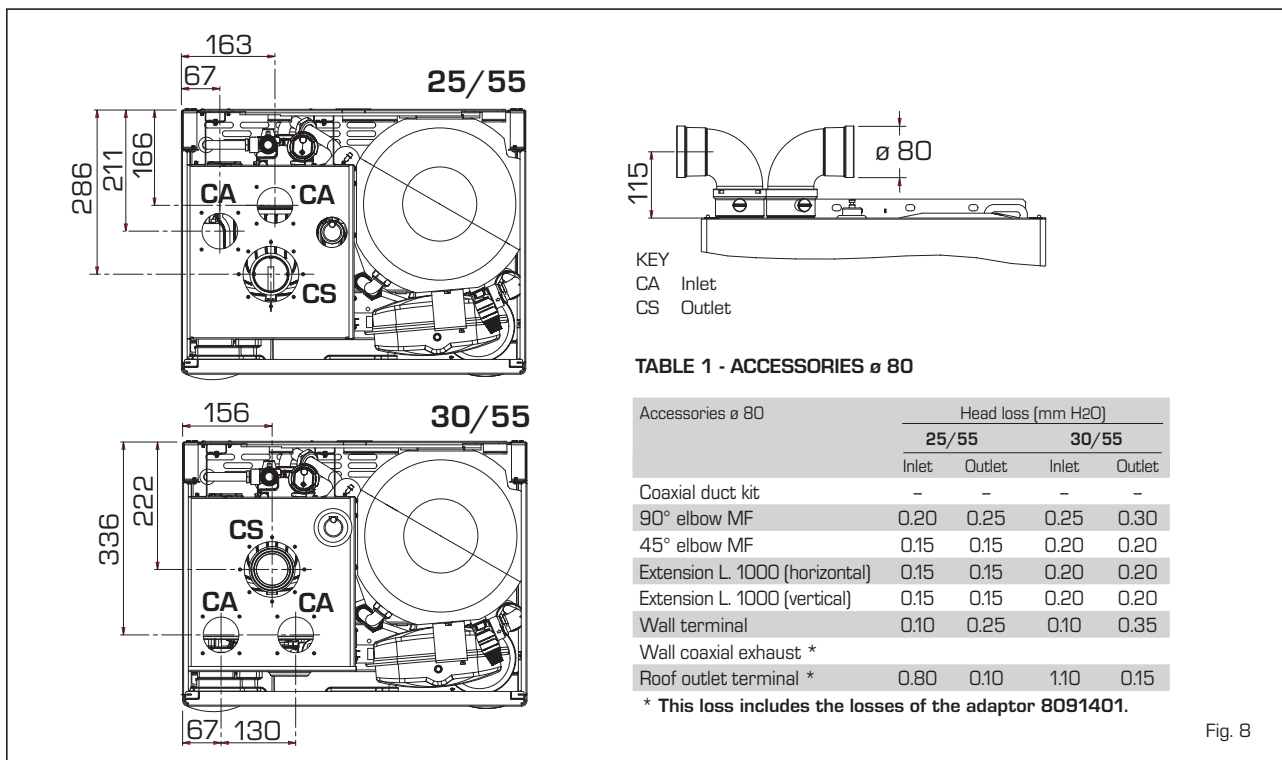

Fig. 8

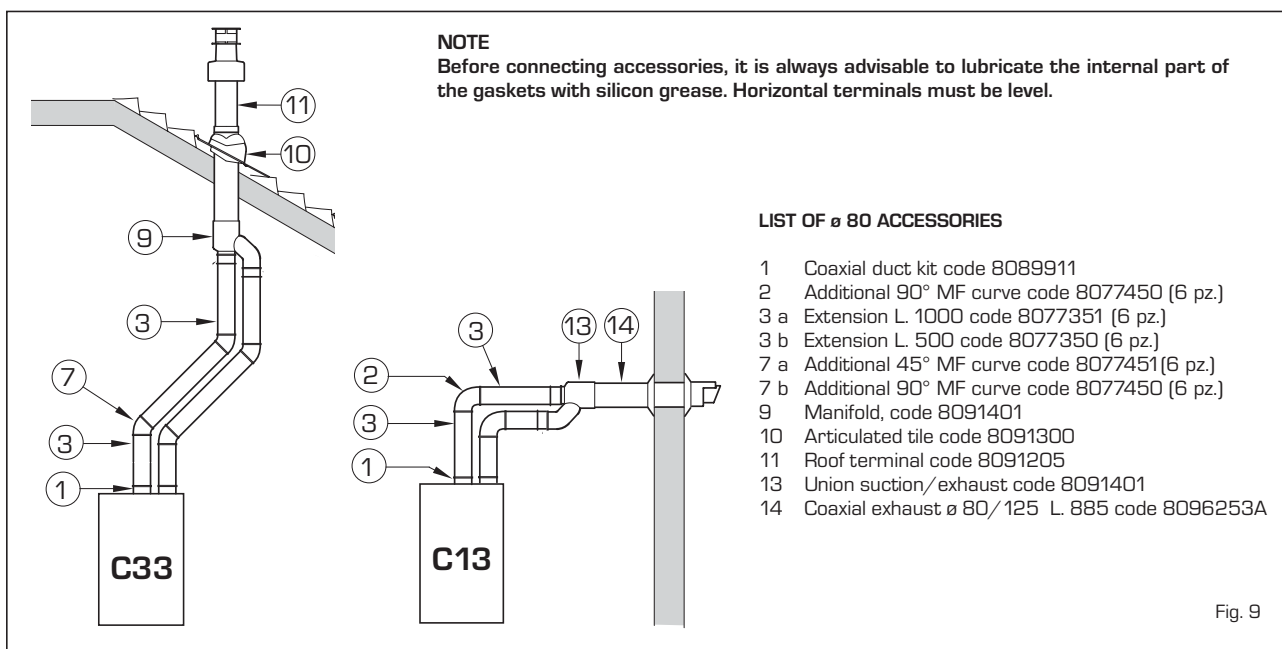

Fig. 9

2.7 POSITIONING THE OUTLET TERMINALS

The outlet terminals for forced-draught appliances may be located in the external perimeter walls and roof of the building. To provide some indications of possible solutions, **Table 2** gives the minimum distances

to be observed, with reference to the type of building shown in fig. 9.

2.8 ELECTRICAL CONNECTION

The boiler is supplied with an electric cable. Should this require replacement, it must be

purchased exclusively from SIME.

The electric power supply to the boiler must be 230V - 50Hz single-phase through a fused main switch, fused at 3 amps with at least 3 mm spacing between contacts.

Respect the L and N polarities and the earth connection.

NOTE: SIME declines all responsibility for

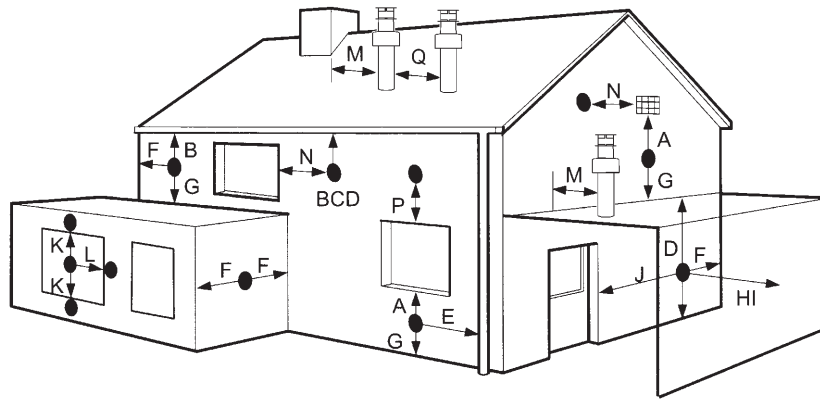

TABLE 2

Terminal position	Minimum spacing
A Directly below an openable window, air vent or any other ventilation opening	300 mm 12 in
B Below guttering, drain pipes or soil pipes	75 mm 3 in
C/D Below eaves, balconies or carport roof (*)	200 mm 8 in
E From vertical drain pipes or soil pipes	75 mm 3 in
F From internal or external corners	300 mm 12 in
G Above adjacent ground, roof or balcony level	300 mm 12 in
H From a boundary or surface facing the boiler	600 mm 24 in
I From a terminal facing the terminal	1,200 mm 48 in
J From an opening in the carport (eg door; window into dwelling)	1,200 mm 48 in
K Vertically from a terminal on the same wall	1,500 mm 60 in
L Horizontally from a terminal on the same wall	300 mm 12 in
M Horizontally from a vertical terminal to a wall	300 mm 12 in
N Horizontally from an openable window or other opening	300 mm 12 in
P Above an openable window or other opening	300 mm 12 in
Q From an adjacent vertical terminal	600 mm 24 in

* this distance can be reduced to 25 mm provided surfaces are protected from the effects of condensate

- If the terminal discharges into a pathway or passageway check that combustion products will not cause nuisance and that the terminal will not obstruct the passageway.
- Where the lowest part of the terminal is fitted less than 2 m (78 in) above ground, above a balcony or above a flat roof to which people have access, the terminal **MUST** be protected by a purpose designed guard.
- Where the terminal is fitted within 850 mm (34 in) of a plastic or painted gutter, or 450 mm (18 in) of painted eaves, an aluminium shield at least 1,500 mm (59 in) long must be fitted to the underside of the painted surface.
- The air inlet/outlet flue duct **MUST NOT** be closer than 25 mm (1 in) to combustible material.
- In certain weather conditions the terminal may emit a plume of steam. This is normal but positions where this would cause a nuisance should be avoided.

Fig. 9

injury or damage to persons ,animals or property, resulting from the failure to provide for proper earthing of the appliance.

2.8.1 Room Thermostat

The heat demand can be by a "clean contact" (conforming to EN607301), room stat or programmer connected to the "TA" connection [fig 11] , CN6 terminals 7&8, after removing the link.

Alternatively the heat demand can be by a 230v switched control, connected to terminal 14 on connector CN7 and removal of the TA link.

2.8.2 External Control CR 53

A CR 53 external control (part number 8092227),can be connected to the boiler. This will control the heating function of the boiler. The domestic hot water will continue

to be controlled by the boiler keypad.

NOTE: Reset parameter 10 to 2 (PAR 10 = 2).

2.8.3 Remote control CR 73 connection (optional)

The boiler is designed for connection to a remote control unit, supplied on request (code 8092226). The remote control unit CR 73 allows for complete remote control of the boiler, except reset.

The boiler display will show the following message:

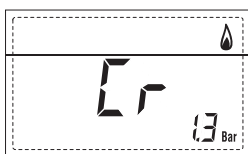

For installation and use of the remote con-

trol, follow the instructions in the package.

NOTE: Ensure PAR 10 set to 1 (PAR 10 = 1).

2.8.4 External sensor connection

The boiler is designed for connection to an external temperature sensor, supplied on request (code 8094101), which can automatically regulate the temperature value of the boiler output according to the external temperature.

For installation, follow the instruction in the package.

2.8.5 Remote RF control

The boiler is designed for connection to RF remote controllers(mechanical - code 8092231 or digital - code 8092232), which can control the central heating function.

2.8.6 Use with different electronic systems

Some examples are given below of boiler systems combined with different electronic systems. Where necessary, the parameters to be set in the boiler are given.

The electrical connections to the boiler refer to the wording on the diagram (fig. 11). The zone valve control starts at every demand for heating of the zone 1 (it is from part of the TA1 or the CR).

Description of the letters indicating the components shown on the system diagrams:

M	System output
R	System return
CR	Remote control CR 73
SE	External temperature sensor
TA1-2-3-4	Zone room thermostat
CT1-2	Zone room thermostat internal time clock
VZ1-2	Zone valve
RL1-2-3-4	Zone relay
SI	Hydraulic separator
P1-2-3-4	Zone pump
IP	Floor system
EXP	Expansion card Mixed Zone (code 8092234)
VM	Three-way mixer valve

1 BASIC SYSTEM

SYSTEM WITH A DIRECT ZONE AND ROOM THERMOSTAT, OR WITH A CLIMATIC REGULATOR CR 53 (Code 8092227) OR WITH REMOTE CONTROL CR 73 (Code 8092226) AND EXTERNAL SENSOR (Code 8094101)

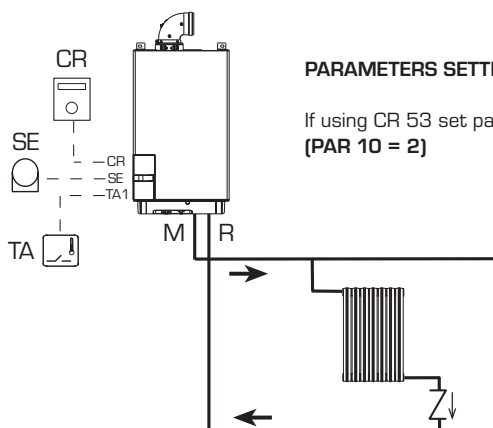

PARAMETERS SETTINGS

If using CR 53 set parameter 10 to 2 (PAR 10 = 2)

2 BASIC SYSTEM

MULTI-ZONE SYSTEM WITH PUMP, ROOM THERMOSTAT AND EXTERNAL SENSOR (Code 8094101)

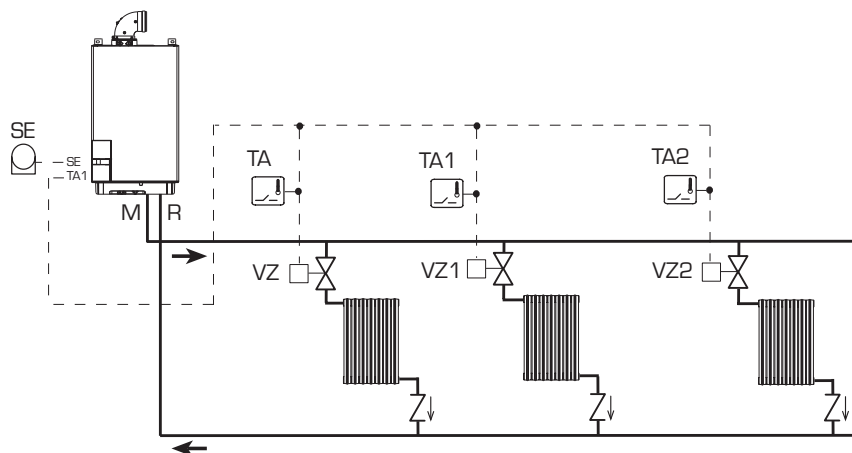

3 BASIC SYSTEM

MULTI-ZONE SYSTEM WITH PUMP, ROOM THERMOSTAT AND EXTERNAL SENSOR (Code 8094101)

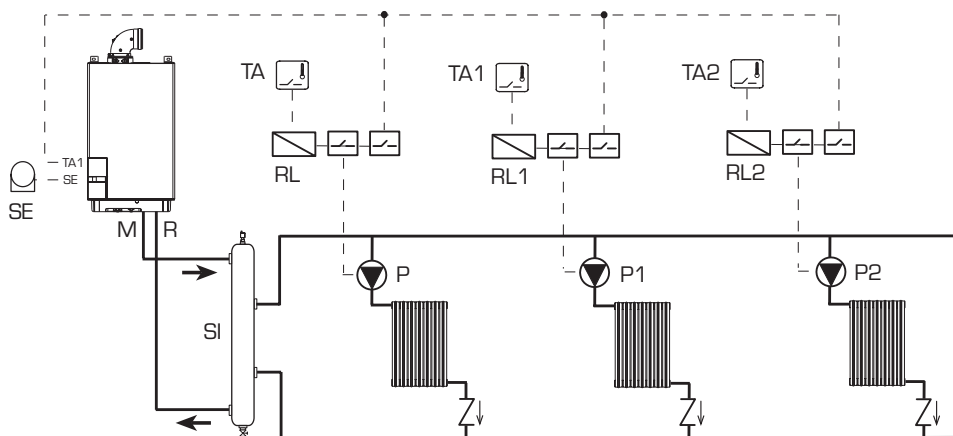

4 BASIC SYSTEM

MULTI-ZONE SYSTEM WITH VALVE, ROOM THERMOSTAT, REMOTE CONTROL CR 73 (Code 8092226) AND EXTERNAL SENSOR (Code 8094101)

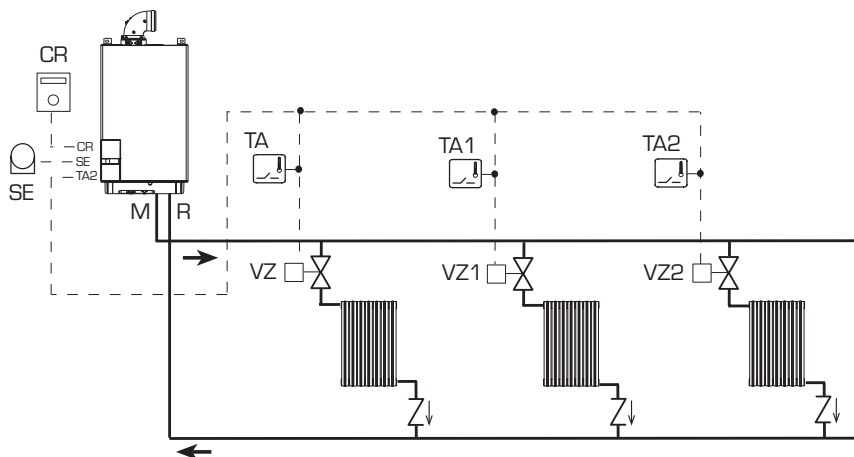

PARAMETERS SETTINGS

To use the remote control (CR) as remote control panel for the boiler rather than as room reference, set:
PAR 7 = 0

5 BASIC SYSTEM
MULTI-ZONE SYSTEM WITH VALVE, ROOM THERMOSTAT, REMOTE CONTROL CR 73 (Code 8092226)
AND EXTERNAL SENSOR (Code 8094101)

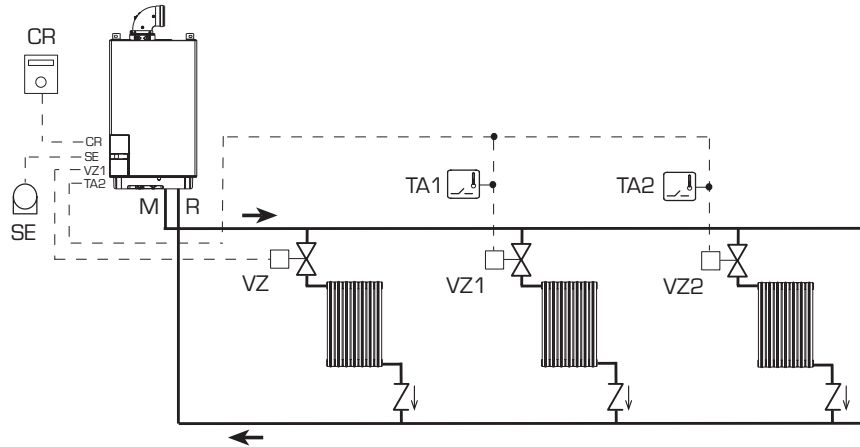

PARAMETER SETTING

To use the remote control (CR) as room reference for a zone, set: **PAR 7 = 1**

Set the opening time of the zone valve VZ: **PAR 33 = "OPENING TIME"**

6 BASIC SYSTEM
MULTI-ZONE SYSTEM WITH PUMP, ROOM THERMOSTAT, REMOTE CONTROL CR 73 (Code 8092226)
AND EXTERNAL SENSOR (Code 8094101)

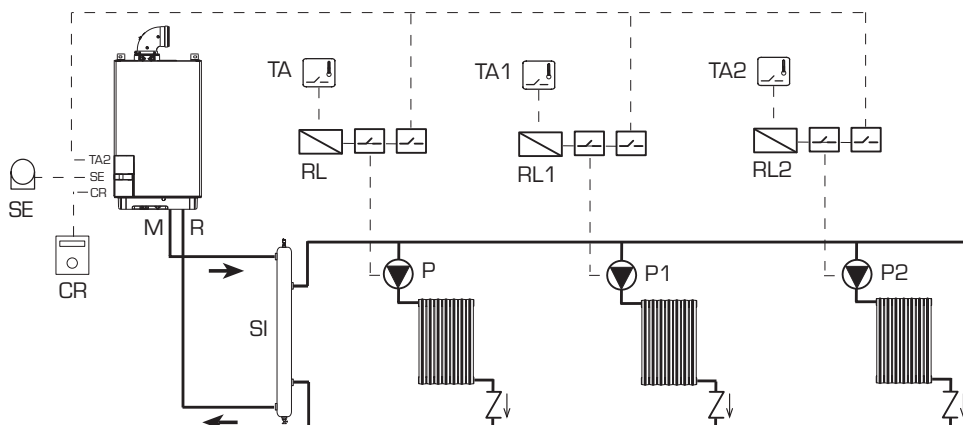

PARAMETER SETTING

To use the remote control (CR) as room reference for a zone, set: **PAR 7 = 1**

**7 SYSTEM WITH DOUBLE TEMPERATURE OUTPUT
MULTI-ZONE SYSTEM WITH VALVE, ROOM THERMOSTAT INTERNAL TIME CLOCK AND EXTERNAL
SENSOR (Code 8094101)**

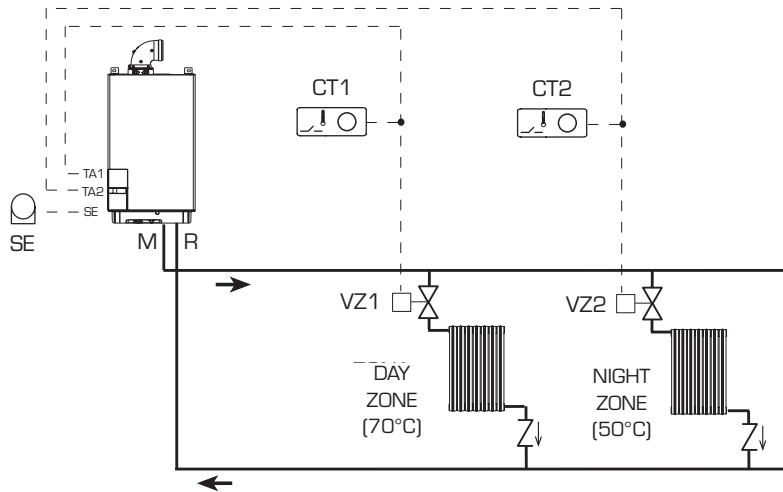

DURING NIGHT TIME THE BOILER USES A LOWER OUTPUT TEMPERATURE IF DIFFERENT TIMES HAVE BEEN SET FOR DAY AND NIGHT AREAS:

- **with external sensor**, set the climatic curve of the day zone 1 with PAR 25 and the night zone at PAR 26.
- **without external sensor**, gain access to setting the day zone 1 by pressing the key and change the value with the keys and . Gain access to setting the night zone by pressing the key twice and changing the value with the keys and .

**8 SYSTEM WITH DOUBLE TEMPERATURE OUTPUT
MULTI-ZONE SYSTEM WITH PUMP, ROOM THERMOSTAT INTERNAL TIME CLOCK AND EXTERNAL
SENSOR (Code 8094101)**

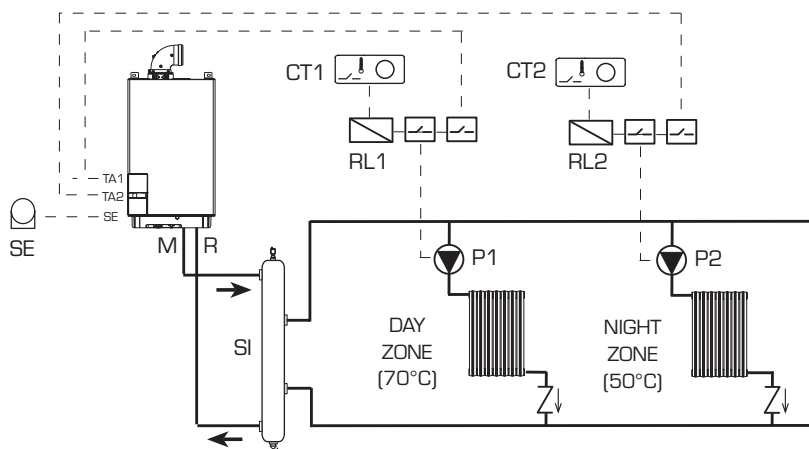

**11 SYSTEM WITH MIXER VALVE
SYSTEM WITH ONE DIRECT ZONE AND ONE MIXED ZONE**

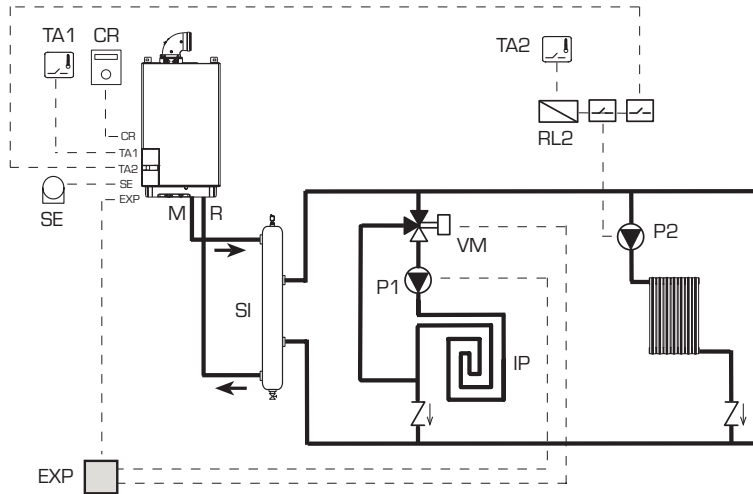

PARAMETERS SETTINGS

To use the remote control (CR) as remote control panel for the boiler rather than as room reference, set:
PAR 7 = 0

**12 SYSTEM WITH MIXER VALVE
SYSTEM WITH TWO DIRECT ZONES AND TWO MIXED ZONES**

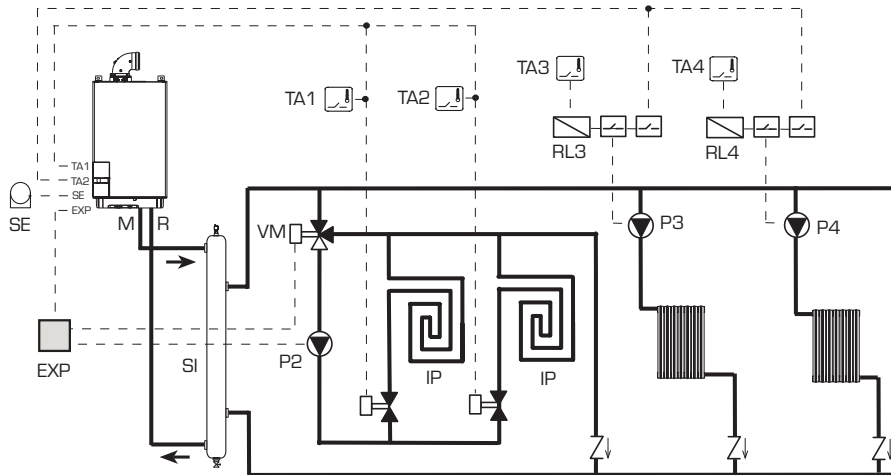

**13 SYSTEM WITH MIXER VALVE
SYSTEM WITH TWO MIXED ZONES INDEPENDENT AND TWO KITS ZONA MIX (Code 8092234)**

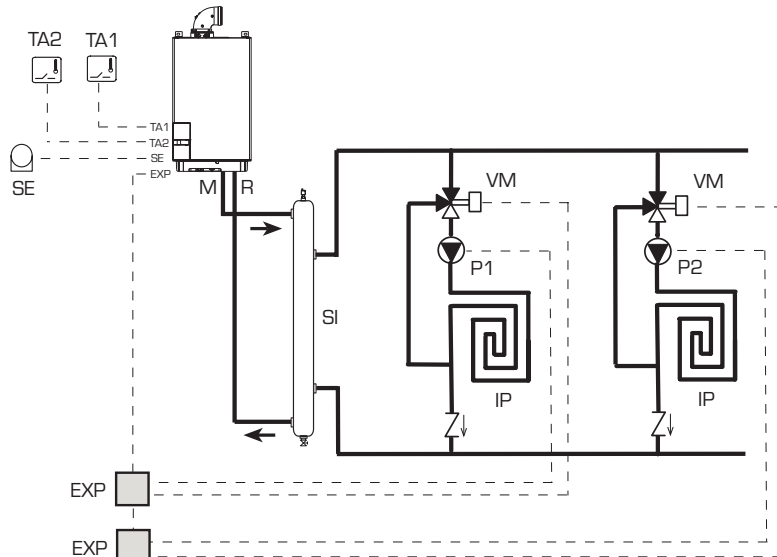

2.9 BOILER ELECTRICAL

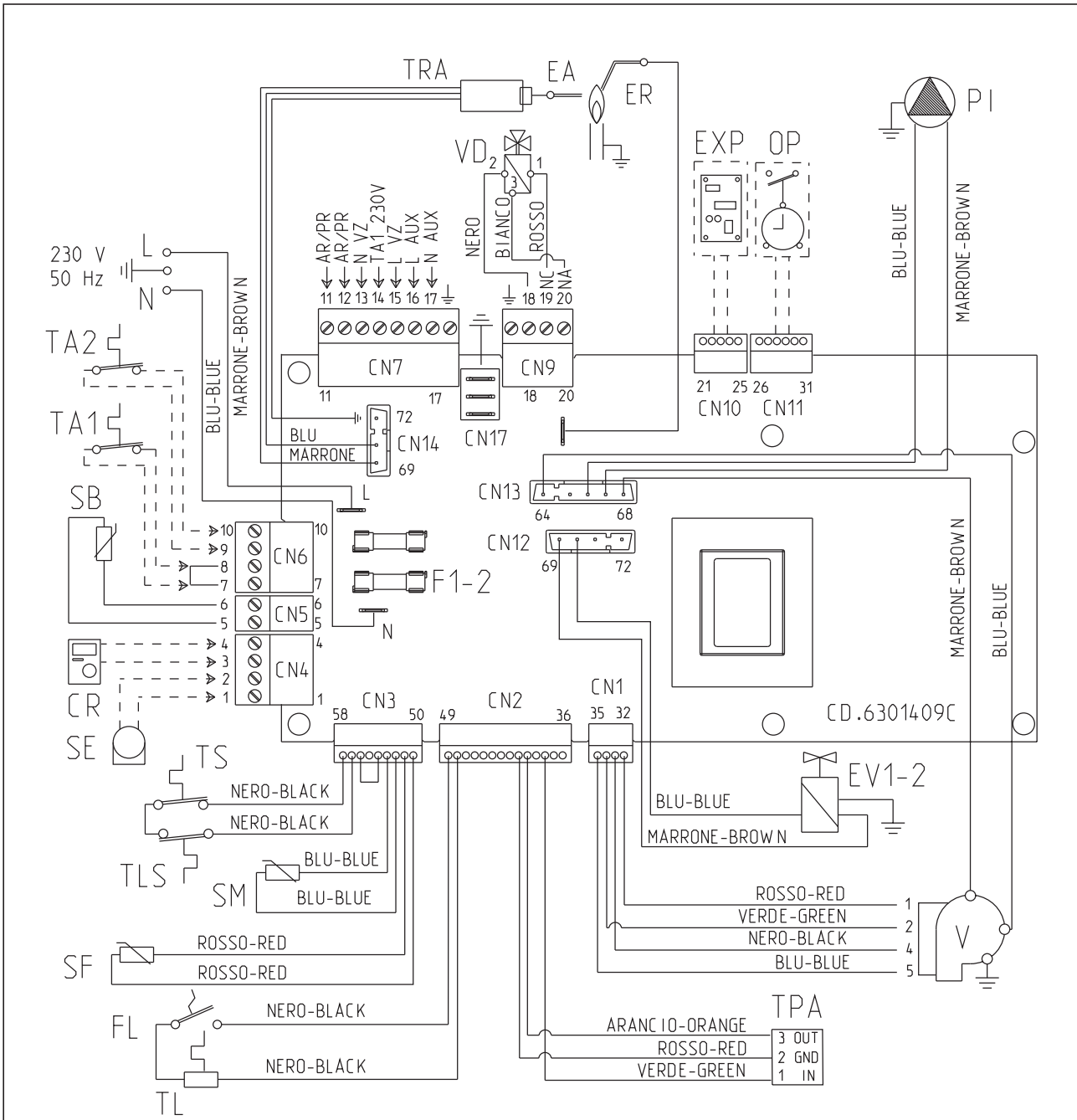

KEY

- F1-2 Fuse (4 AT)
- TRA Ignition transformer
- PI Pump
- V Fan
- EA Ignition electrode
- ER Ionisation electrode
- EV1-2 Gas valve coil
- TS Safety thermostat
- SF Exhaust fumes sensor
- TL Limit stat
- SM Heating sensor
- FL Water flow switch
- VD Diverter valve
- TPA Pressure transducer
- TA1 Zone 1 environment thermostat
- TA2 Zone 2 environment thermostat
- SB D.H.W. sensor

- CR Remote control CR 73 (optional)
- SE External sensor (optional)
- OP Programming clock (optional)
- EXP Expansion card
- AR/PR Recirculation pump control or remote alarm
- VZ Zone valve
- AUX Auxiliary connection
- TLS D.H.W. over heating thermostat: 85°

NOTE: Boiler heating control can be by either voltage free switching on terminals 7 & 8 of CN 6 after removal of the link, or by a 240 v demand on terminal 14 CN7 and removal of the link on 7 & 8 on CN6. A permanent power supply must be maintained at all times.

CONNECTOR SPARE PART CODES:

- CN1/CN13 code 6316231
- CN2 code 6316233
- CN3 code 6316276
- CN4 code 6316203
- CN5 code 6316200
- CN6 code 6316202
- CN7 code 6316204
- CN9 code 6316201
- CN10 cod. 6316227
- CN11 cod. 6316226
- CN12 code 6299991
- CN14 code 6316230

Fig. 11

3 CHARACTERISTICS

3.1 CONTROL PANEL

2 - DESCRIPTION OF CONTROLS

ON/STANDBAY
ON = The boiler is on
STANDBAY = The boiler is off, but the protection functions are active.

SUMMER MODE KEY
When this key is pressed, the boiler functions only when D.H.W. is requested.

WINTER MODE KEY
When this key is pressed, the boiler provides heating and D.H.W.

D.H.W. TEMP KEY
When this key is pressed, the temperature of the D.H.W. is shown on the display.

HEATING TEMP KEY
The first time the key is pressed, the temperature of heating circuit 1 is shown.
The second time the key is pressed, the temperature of heating circuit 2 is shown.

RE-SET KEY
Press to reset a resettable error.

INCREASE AND DECREASE KEY
By pressing this key the set value increases or decreases.

DESCRIPTION OF DISPLAY ICONS

SUMMER MODE ICON

WINTER MODE ICON

D.H.W. MODE ICON

HEATING MODE ICON
1 = First circuit heating system
2 = Second circuit heating system

GRADED POWER SCALE
The segments of the bar light up in proportion to boiler power output.

BURNER FUNCTIONING AND LOCKOUT ICON

RESET REQUIRED

CHIMNEY SWEEP ICON

SECONDARY DIGITS
The boiler displays the value of the pressure of the system (correct value is between 1 and 1.5 bar)

MAIN DIGITS
The boiler displays the values set, the state of anomaly and the external temperature

INTEGRATIVE SOURCES ICON

3 - KEYS RESERVED FOR THE INSTALLER (access to INST and OEM parameters)

PC CONNECTION
To be used only with the SIME programming kit and only by authorised personnel. Do not connect other electronic devices (cameras, telephones, mp3 players, etc.) Use a tool to remove the cap and reinsert after use.
ATTENTION: Communication port sensitive to electrostatic charges.
Before use, it is advisable to touch an earthed metallic surface to discharge static electricity.

INFORMATION KEY
This key can be pressed several times to view the parameters.

CHIMNEY SWEEP KEY
This key is used to engage the chimney sweep function and also used to view the parameters.

DECREASE KEY
This key changes the default settings.

INCREASE KEY
This key changes the default settings.

4 - LUMINOUS BAR



Blue = Operating normally
Red = operating error

5 - PROGRAMMING CLOCK (optional)

Mechanical clock (code 8092228) or digital clock (code 8092229) Analogic RF time/temperature programmer (code 8092231), Digital RF time/temperature programmer (code 8092232).

Fig. 12

3.2 ACCESS TO INSTALLER'S INFORMATION

For access to information for the installer, press the key  (3 fig. 14). Every time the key is pressed, the display moves to the next item of information. If the key  is not pressed, the system automatically quits the function. List of information:

1. Display of external temperature, only with external sensor connected

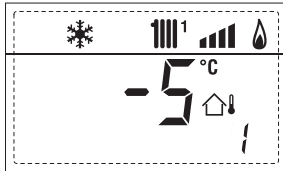

2. Display of heating temperature sensor (SM)

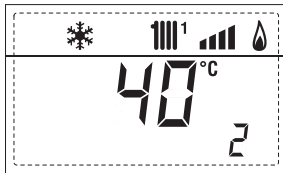

3. Display of D.H.W. temperature sensor (SS)

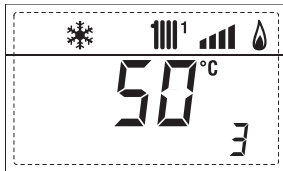

4. Display of auxiliary temperature sensor

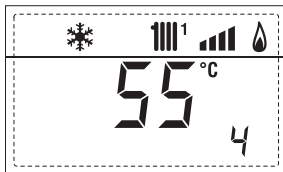

5. Display of smoke temperature sensor

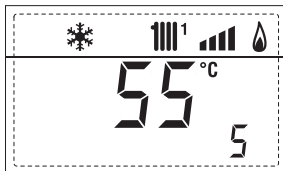

6. Display of heating temperature of first circuit

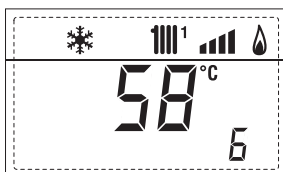

7. Display of heating temperature of second circuit

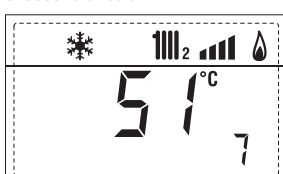

8. Display of ionisation current in µA



9. Display of fan speed in rpm x 100 (eg 4.800 and 1850 rpm)



10. Display of the number of hours x100 the burner has been alight (eg 14000 and 10)



11. Display of number of times the burner has ignited x 1000 (eg 97000 and 500)



12. Display of code of last error

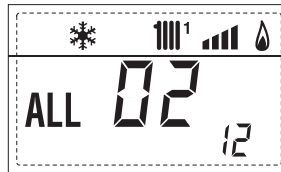

13. Display of code of penultimate error

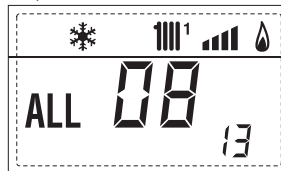

14. Display of total number of errors

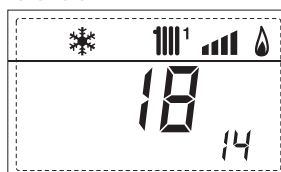

15. Installer parameter access counter (example = 140 accesses)



16. OEM access counter (example = 48 accesses)



17. Display of D.H.W. flowmeter load (i.e. 18 l/min and 0.3 l/min) or flow switch (respectively ON and OFF)

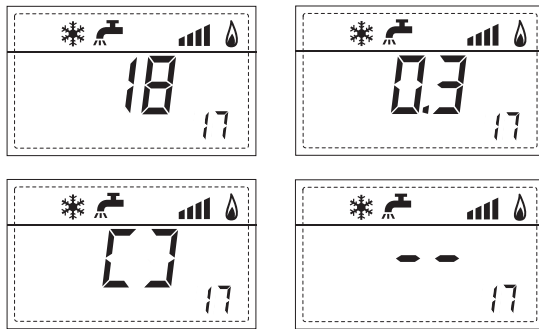

18. Display of delivery probe value mixed with board Mixed Zone 1 (input S2)

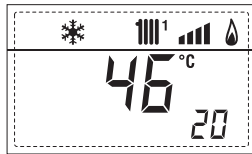

19. Display of safety thermostat Mixed Zone (input S1) respectively ON and OFF

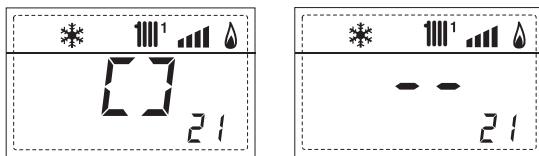

22. Indicator of pump with board Mixed Zone 1 (respectively ON and OFF)

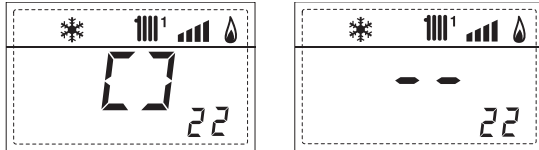

23. Indication of valve opening control with board Mixed Zone 1 (respectively ON and OFF)

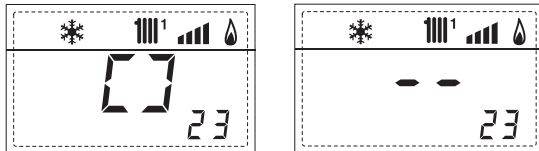

24. Indication of valve closing control with board Mixed Zone 1 (respectively ON and OFF)

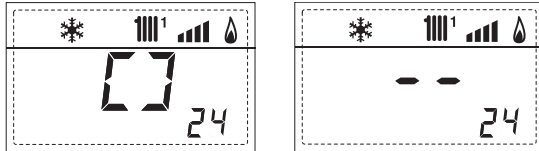

25. Indication of the plant delivery probe mixed with board Mixed Zone 2

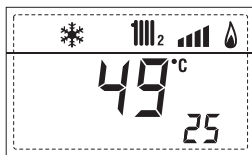

26. Indication of safety thermostat with board Mixed Zone 2 (input S1) respectively ON and OFF

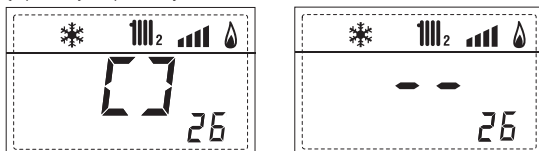

27. Indicator of pump with board Mixed Zone 2 (respectively ON and OFF)

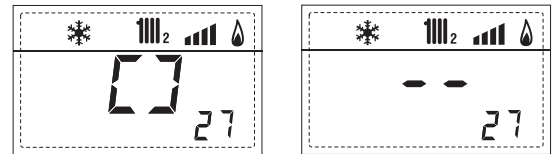

28. Indication of valve opening control with board Mixed Zone 2 (respectively ON and OFF)

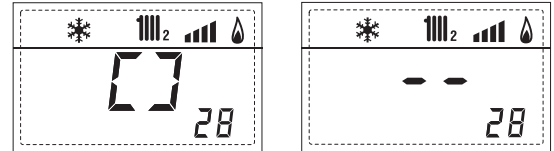

29. Indication of valve closing opening control with board Mixed Zone 2 (respectively ON and OFF)

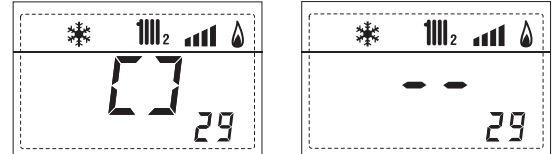

30. Display of solar probe temperature value S1 with solar board

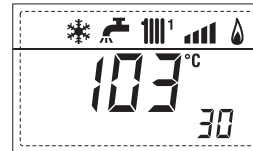

31. Display of solar probe temperature value S2 with solar board

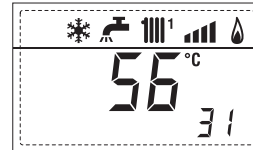

32. Display of solar probe temperature value S3 with solar board

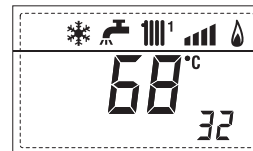

33. Indication of solar relay R1 with solar board (respectively ON and OFF)

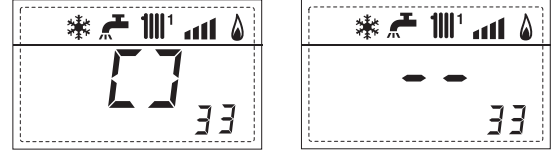

34. Indication of solar relay R2 with solar board (respectively ON and OFF)

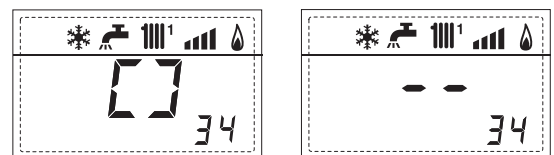

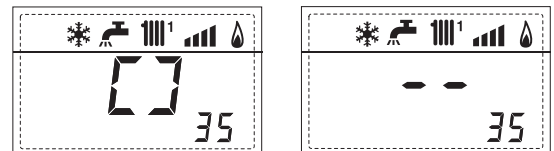

35. Indication of solar relay R3 with solar card (respectively ON and OFF)







3.3 ACCESS TO INSTALLER'S PARAMETERS

Only qualified persons should alter any of the settings or parameters. Incorrect adjustment would cause defective operation and damage the boiler and would invalidate the warranty.

For access to the installer's parameters, press simultaneously the keys  and  or 5 seconds (3 fig. 12).

For example, the parameter PAR 23 is shown on the display of the control panel in the following way:



The parameters scroll forwards and backwards with the key  and  and the default parameters can be changed with the keys  and .

The standard display returns automatically after 60 seconds, or by pressing one of the control keys (2 fig. 12).

3.3.1 Replacement of PCB

Should the PCB be changed, PAR 1 and PAR 2 will require resetting as per the following table.

GAS	MODELS	PAR 1
-	-	1
-	-	2
-	-	3
-	-	4
-	-	5
-	-	6
-	-	7
-	-	8
-	-	9
-	-	10
-	-	11
-	-	12
-	-	13
-	-	14
-	-	15
-	-	16
-	-	17
-	-	18
-	-	19
METHANE (G20)	25/55 30/55	20 21
PROPANE (G31)	25/55 30/55	22 23
-	-	24
-	-	25
-	-	26
-	-	27
-	-	28
-	-	29
-	-	30

PARAMETERS INSTALLER

FAST CONFIGURATION

PAR	DESCRIPTION	RANGE	UNIT OF MEASUREMENT	INC/DEC UNIT	DEFAULT SETTING
1	Combustion configuration	- = ND 1 ... 30	=	=	"-"
2	Hydraulic configuration	- = ND 1 ... 6 1 = DHW + Recirc. pump 2 = DHW 3 = Recirculation pump	=	=	1
3	Pressure transducer disabler	0 = Disabled 1 = Enabled	=	=	1
4	Assignment of auxiliary relay AUX (D.H.W. tank)	1 = Remote supply 2 = Recirculation pump	=	=	1
5	Luminous bar indicating presence of voltage	0 = Disabled 1 = Enabled	=	=	1
6	Allocation of CR73 channels	0 = Not assigned 1 = Circuit 1 2 = Circuits 1 and 2	=	=	1
7	Fan rpm Step ignition	0,0 ... 81	rpmx100	0,1da 0,1a19,9 1da 20 a 81	0,0
8	Long chimneys	0 ... 20 1 = CR 73 2 = CR 53 3 = RVS	%	1	0
9	Remote control option setting	- = Always 1 = Never 1 ... 199	sec. x 10	1	3
10	Correction values external sensor	-5 ... +5	°C	1	0
11	Backlighting duration	0 = Minimum 1 = Maximum 2 = Automatic	=	=	1
12	Modulating pump speed				

D.H.W. - HEATING

PAR	DESCRIPTION	RANGE	UNIT OF MEASUREMENT	INC/DEC UNIT	DEFAULT SETTING
20	D.H.W. minimum temperature	10 °C ... PAR 21	°C	1	30
21	D.H.W. maximum temperature	PAR 20 ... PAR 62 OEM	°C	1	60
22	Anti-legionella (only D.H.W. tank)	0 = Disabled 1 = Enabled	=	=	0
23	Boiler antifreeze	0 ... +10	°C	1	3
24	External sensor antifreeze	- 15 ... +5	°C	1	-2
25	Climatic curve setting Zone 1	3 ... 40	=	1	20
26	Climatic curve setting Zone 2	3 ... 40	=	1	20
27	Minimum temperature Zone 1	PAR 64 OEM ... PAR 28	°C	1	20
28	Minimum temperature Zone 1	PAR 27 ... PAR 65 OEM	°C	1	80
29	Minimum temperature Zone 2	PAR 64 OEM ... PAR 30	°C	1	20
30	Maximum temperature Zone 2	PAR 29 ... PAR 65 OEM	°C	1	80
31	Maximum heating power	30 ... 100	%	1	100
32	C.H. pump over run time	0 ... 199	Sec.	10	30
33	Pump activation delay Zone 1	0 ... 199	10 sec.	1	1
34	Re-ignition delay	0 ... 10	Min.	1	3
35	Integrative sources activation threshold	- , 15 ... 80	°C	1	"-"
36	D.H.W. pump over run time	0 ... 199	Sec.	1	0
39	Saturation zone modulation D.H.W. flowmeter	- = Enabled 0 ... 100	%	1	10

BOILER	PAR 2
Instantaneous boiler with diverter valve microswitch and flow switch	1
Instantaneous boiler with diverter valve microswitch, flow switch and solar combining	2
25/55 - 30/55	3
Only heating version T	4
Instantaneous boiler with diverter valve and flowmeter	5
Instantaneous boiler with diverter valve, flowmeter and solar combining	6

NOTE: A label on the inside of the clock cover (fig. 19) will show the correct values of PAR 1 and PAR 2 assigned to the boiler."

PARAMETERS INSTALLER				
EXPANSION CARD				
PAR DESCRIPTION	RANGE	UNIT OF MEASUREMENT	INC/DEC UNIT	DEFAULT SETTING
40 Number of expansion boards	0 ... 3	=	1	0
41 Mix valve stroke time	0 ... 199	10 sec.	1	12
42 Priority of D.H.W. over mixed zone	0 = Paralle 1 = Absolute	=	=	1
43 Floor drying	0 = No activated 1 = Curve A 2 = Curve B 3 = Curve A+B	=	=	0
44 Type of solar system	0 ... 6	=	1	1
45 Δt solar collector pump 1	PAR 74 OEM - 1... 50	°C	1	8
46 Solar integration delay	"-", 0 ... 199	Min.	1	0
47 Tmin solar collector	"-", -30 ... 0	°C	1	- 10
48 Tmax solar collector	"-", 80 ... 199	°C	1	120
PARAMETERS RESTORATION				
PAR DESCRIPTION	RANGE	UNIT OF MEASUREMENT	INC/DEC UNIT	DEFAULT SETTING
49 * Reset default parameters (par 01 - par 02 = "-")	- , 1	=	=	=
* In case of difficulty in understanding the current setting or in case of an anomalous or incomprehensible conduct of the boiler, we suggest to restore the initial values of the parameters setting PAR 49 = 1 and the PAR 1 and PAR 2 as specified at point 3.3.1.				

3.4 EXTERNAL SENSOR

If there is an external sensor, the heating settings SET can be taken from the climatic curves according to the external temperature and, in any case, limited to with the range values described in point 3.3 (parameters PAR 25 for zone 1 and PAR 26 for zone 2).

The climatic curve to be set can be selected from a value of 3 and 40 (at step 1). Increasing the steepness of the curves of fig. 13 will increase the output temperature as the external temperature decreases.

3.5 CARD FUNCTIONING

The electronic card has the following functions:

- Antifreeze protection of the heating and D.H.W. circuits (ICE).
- Ignition and flame detection system.
- Control panel setting for the power and the gas for boiler functioning.
- Anti jamming for the pump which is fed for a few seconds after 24 hours of inactivity.
- Antifreeze protection for boilers with D.H.W. storage tank.
- Chimney sweep function which can be activated from the control panel.
- Temperature which can be shifted with the external sensor connected. It can be set from the control panel and is active on the heating systems of both circuit 1 and circuit 2.
- Management of two independent heating circuit systems.
- Automatic regulation of the ignition power and maximum heating. Adjustments are managed automatically by the electronic card to guarantee maximum flexibility in use of the system.
- Interface with the following electronic systems: climatic regulator CR 53, remote control CR 73, thermal regulator RVS and connected to a management card of a MIXED ZONE code 8092234.

NOTE: If using CR 53 or RVS set parameter 10 to 2 (PAR 10 = 2).

3.6 TEMPERATURE DETECTION SENSOR

Table 4 gives the values of the electrical element (Ω) obtained on the DHW and exhaust fumes sensors according to the variations in temperature.

When the heating sensor (SM) and fumes sensor (SF) is interrupted, the boiler will not function.

With the D.H.W. sensor (SB) interrupted the boiler, will function in the CH mode only.

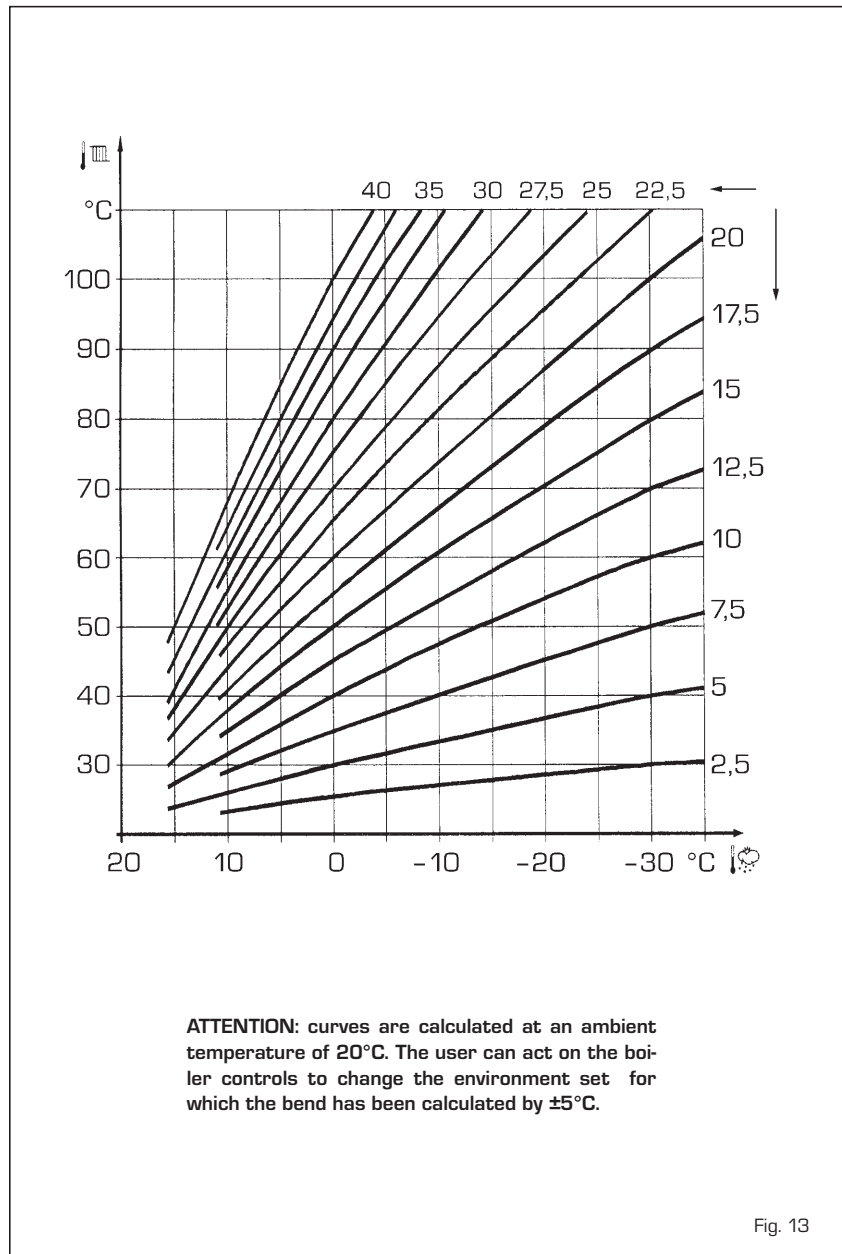

Fig. 13

TABLE 4

Temperature (°C)	Resistance (Ω)
20	12.090
30	8.313
40	5.828
50	4.161
60	3.021
70	2.229
80	1.669

3.7 ELECTRONIC IGNITION

Ignition and flame detection is controlled by electrodes on the burner which guarantees reaction in the case of accidental extinction or lack of gas within one second.

3.7.1 Functioning cycle

Burner ignition should occur within 10

seconds of the opening of the gas valve. If after three attempts the ignition is not detected the boiler will lockout (ALL 06):

- Lack of gas

The ignition electrode will discharge for a maximum of 10 seconds. If after three attempts the ignition is not detected the boiler will lockout (ALL 06).

This can happen the first time a boiler is switched on, or after long periods of inactivity. It can also be caused by a closed gas cock or a gas valve not operating.

- No ionisation

The boiler will spark for 10 seconds, if after 3 attempts the ionisation is not detected, the boiler will lockout (ALL 06).

This could be due to a poor connection or break in the ionisation cable.

Check also that the cable is not shorted, badly worn or distorted.

In the case of a sudden lack of voltage, the burner will immediately switch off.

When voltage returns, the boiler will automatically start up again.

3.8 WATER FLOW SWITCH

The water flow gauge (4 fig. 3) intervenes, blocking burner operation in the case of low pressure or pump failure.

NB: when replacing the flow meter valve, ensure that the arrow printed on its body is pointing in the same direction the water flow.

3.9 HEAD AVAILABLE TO SYSTEM

Residual head for the heating system is shown as a function of rate of flow in the graph in fig. 14.

The speed of the modulating pump is set as default (installation parameter **PAR 13=1**).

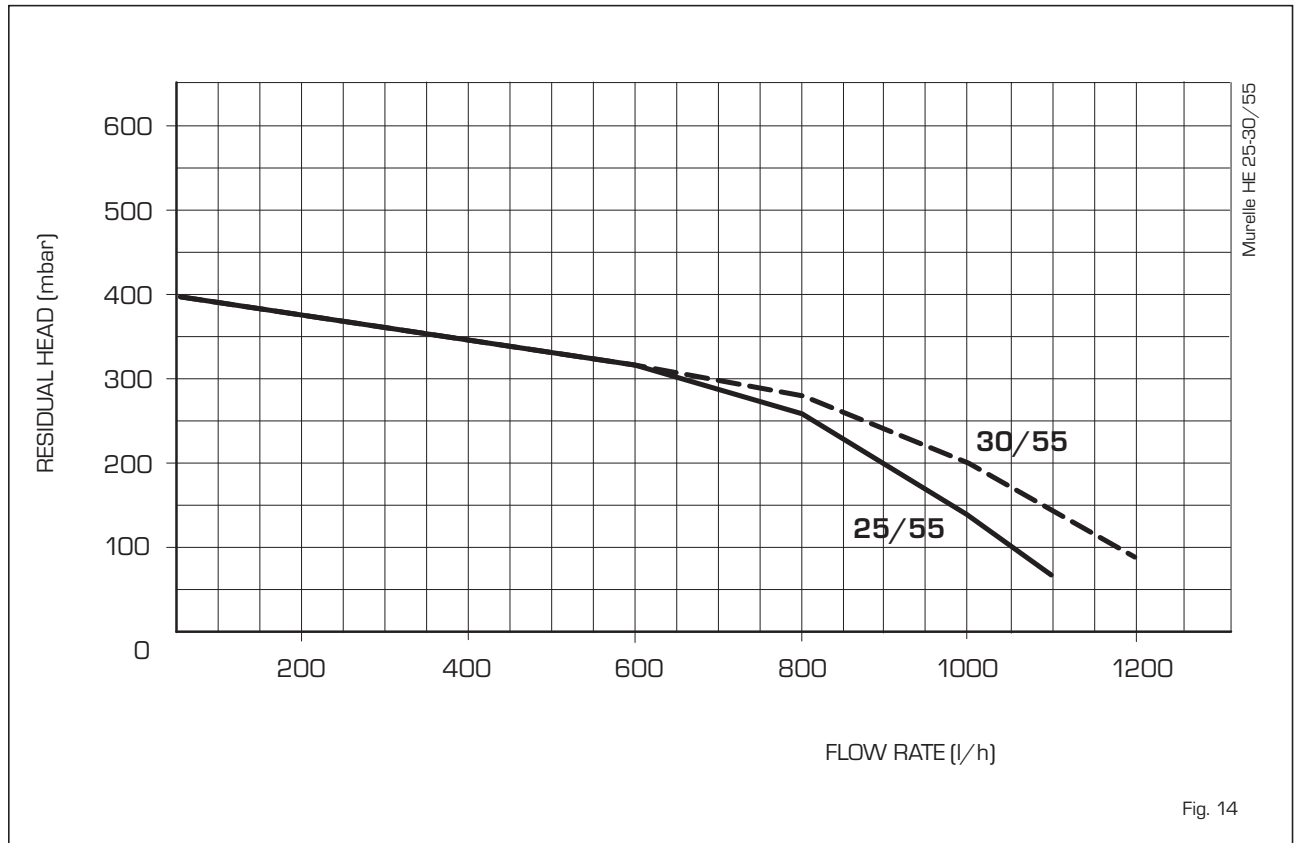

4 USE COMMISSIONING, AND MAINTENANCE

GENERAL

PLEASE NOTE: During routine servicing, and after any maintenance or change of part of the combustion circuit, the following must be checked:

- The integrity of the flue system and the flue seals.
- The integrity of the boiler combustion circuit and the relevant seals.
- The operational (working) gas inlet pressure at maximum rate.
- The combustion performance as described in 4.3.2.

4.1 D.H.W. PRODUCTION

Domestic hot water is provided via the internal storage cylinder. This cylinder is fitted with a sacrificial magnesium anode.

The magnesium anode must be checked regularly, at least annually and replaced when required. Failure to replace when required will result in internal damage to the cylinder and void the warranty. See section 6.15 regarding checking and replacement of the anode.

4.2 GAS VALVE

The boiler is supplied as standard with a gas valve, model SIT 848 SIGMA (Fig. 16).







4.3 GAS CONVERSION (fig. 17)

This operation must be performed by authorised personnel using original Sime components.

To convert from natural gas to LPG or vice versa, perform the following operations

- Close the gas cock.
- Replace the nozzle (1) and the gasket (2) using those supplied in the conversion kit.
- Test all the gas connection using leak detection fluid. Do not use open flames.
- Apply the nameplate with the new gas flow layout.
- Calibrate the maximum and minimum pressures of the gas valve following the instructions provided in paragraph 4.3.2.

4.3.1 New fuel configuration

For access to the installer's parameters, press simultaneously keys  and  for 5 seconds (3 fig. 12). Scroll through the parameters using the  and  buttons. The parameters will scroll up and down with the keys  and . The display pane will show the values of the parameter PAR 1. If the boiler is a 25/55 methane (G20) model, SET 20 will be displayed:

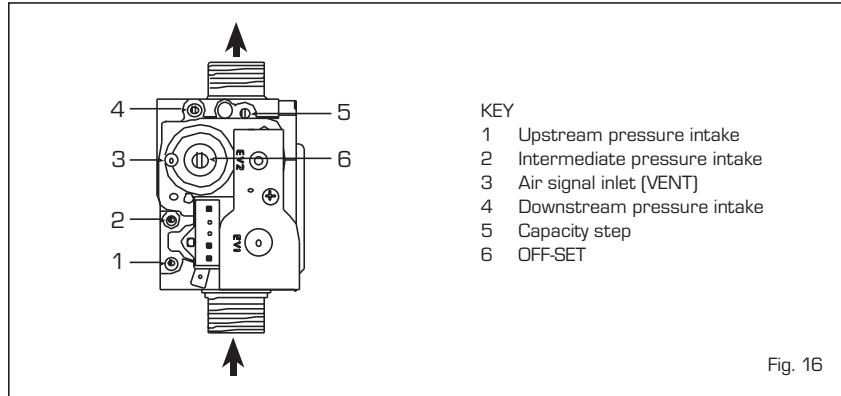

Fig. 16

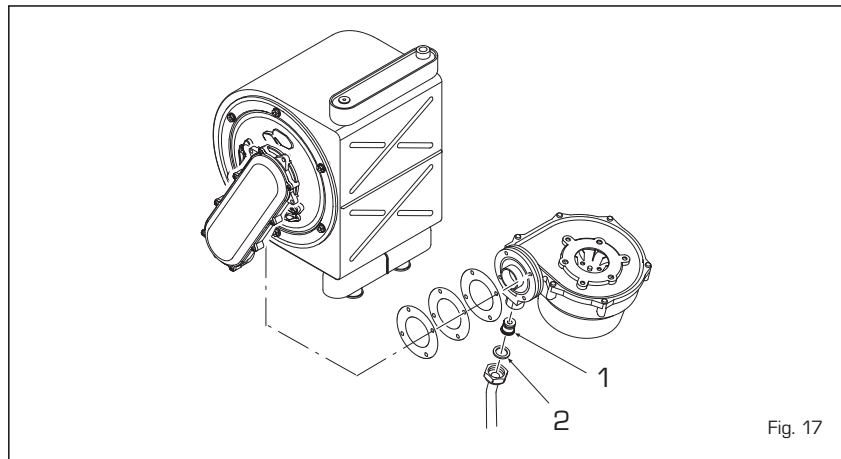

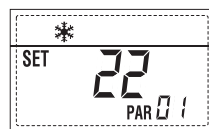

Fig. 17

To change the fuel to propane (G31), it is necessary to set SET 22, by pressing the key .

The standard display will automatically return after 10 seconds.



The table below shows the SET settings to enter when the type of gas fuel is changed.

GAS	MODELS	PAR 1
-	-	1
-	-	2
-	-	3
-	-	4
-	-	5
METHANE (G20)	25/55	20
PROPANE (G31)	30/55	21
-	-	22
-	-	23
-	-	24
-	-	25
-	-	30

4.3.2 Calibrating the gas valve pressures

This can only be done using a flue gas analy-

ser. If the combustion reading is greater than the acceptable value AND the integrity of the complete flue system and combustion seals have been verified, and the inlet gas pressure has been verified then adjustments to the gas valve can be made as described below. Make only small adjustments (1/8 turn max), and allow time for the combustion analysis to be made before making further adjustments.

Sequence of operations:

1) Press and hold the button down for a few seconds  (see 4.5.1)

2) Press the button for a few seconds .



3) Identify the CO₂ values at max. power by adjusting the shutter (5 in Fig. 16):

MAX power	
CO ₂ (Methane)	CO ₂ (Propane)
9,0 ±0,3	10,0 ±0,3

4) Press the button for a few seconds .

5) Identify the CO₂ values at min. power by adjusting the OFF-SET regulation screw (6 in Fig. 16):

MIN power	
CO ₂ (Methane)	CO ₂ (Propane)
9,0 ±0,3	10,0 ±0,3

6) Press the buttons several times to check the pressures  and  change them if required.

7) Press the button  once more to quit the function.

4.3 CO / CO2 RATIO

		CO ppm	
		100	400
CO ₂ %	NG 9%	0,0011	0,0044
	LPG 10%	0,0010	0,0040

4.4 REMOVING THE COVERS

It is possible to completely remove the covers for easier access as shown in fig. 19.

19. the control panel can be hinged forward after removing the front cover and the retaining screw 3.

4.5 MAINTENANCE

To ensure correct operation and efficiency it is important that the boiler is serviced at

annually and that this is recorded in the Benchmark record sheet (page 35).

During the service the condensate drain can be checked. it is important that should the boiler not be used for some time, that the trap is checked and filled if required (see fig. 20).

4.5.1 Chimney sweep function (fig. 21)

To check the boiler combustion(CO₂) press the chimney sweep button  for a few

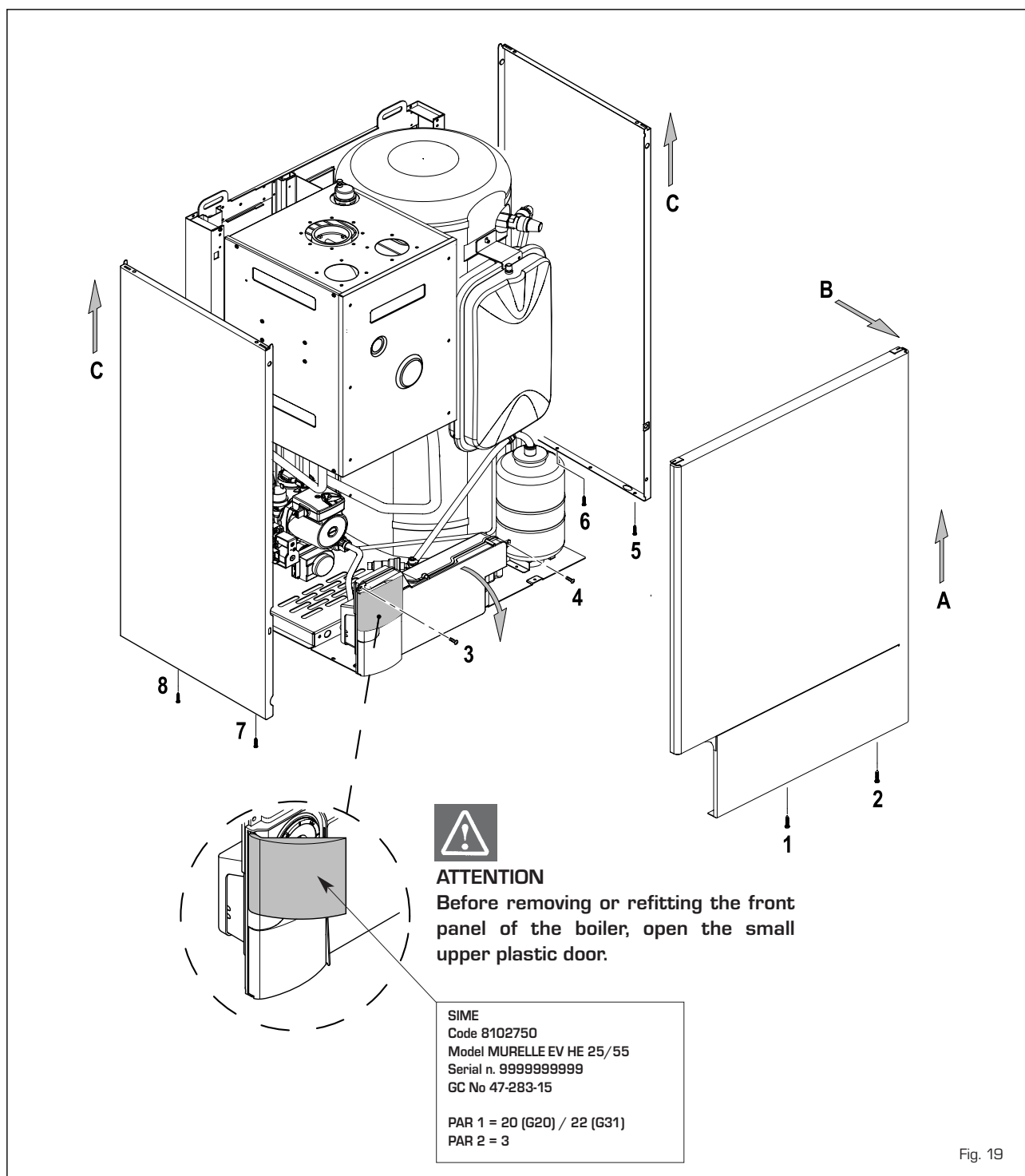



Fig. 19

seconds, the Chimney sweep icon will illuminate. The boiler will ignite and continue for 15 minutes in heating mode. The burner will turn off at 80 degrees and reignite at 70 degrees.

(Warning! Ensure adequate circulation around heating system before activating the Chimney sweep function).

If the  and  keys are pressed during the 15 minutes the boiler will be brought respectively to max and min output. The chimney sweep function will automatically cancel after 15 minutes or if the chimney sweep button is pressed again.

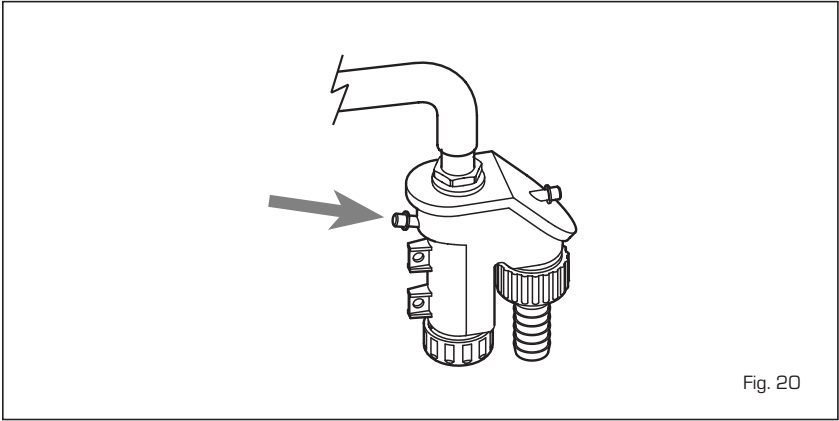

Fig. 20

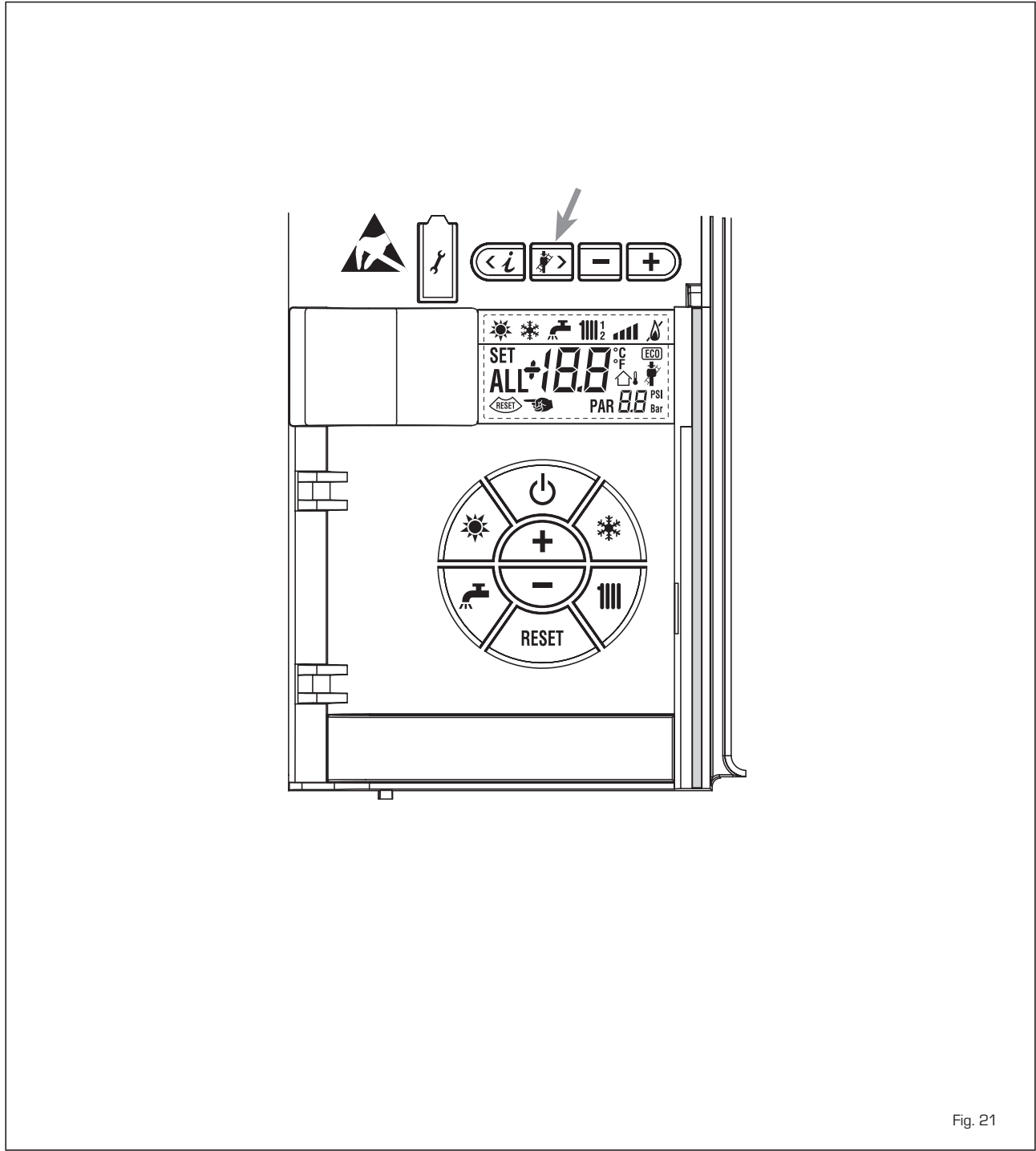

Fig. 21

4.6 FUNCTIONING ERRORS

Where there is a functioning error an alarm appears on the display. The blue luminous bar may turn red.

Descriptions of the error are given below:

- FLUE TEMPERATURE

ALARM 01 (fig. 23)

Check link on terminals 54-56 at PCB.

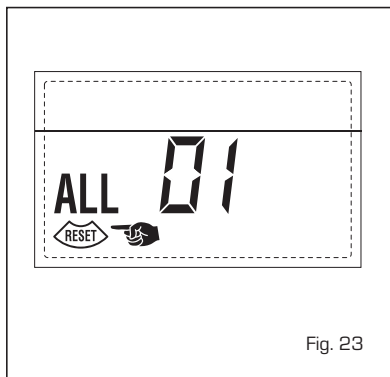

Fig. 23

- LOW SYSTEM PRESSURE

ALARM 02 (fig. 23/a)

If the system pressure detected by the transducer is lower than 0.5 bar the boiler will stop and display error "ALL 02". Increase the system pressure to between 1.0 and 1.5 bar using the external filling loop. The boiler will automatically resume operating.

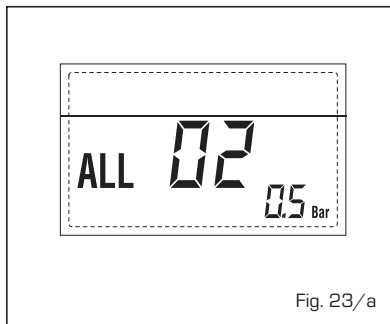

Fig. 23/a

- HIGH SYSTEM PRESSURE

ALARM 03 (fig. 23/b)

If the system pressure detected by the transducer is more than 2.8 bar, the boiler will stop and display "ALL 03". Drain water from the system until the pressure is between 1.0 and 1.5 bar. Ensure

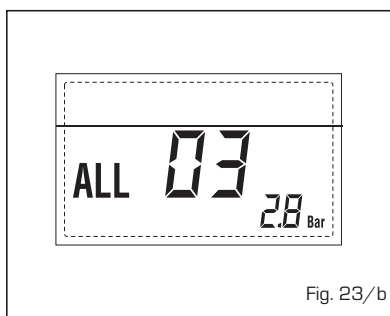

Fig. 23/b

that the filling loop is disconnected. If the problem persists, seek technical advice.

- HEATING SENSOR

ALARM 05 (fig. 23/d)

If the heating sensor (SM) is open or short circuit, the boiler will stop operating and display "ALL 05".

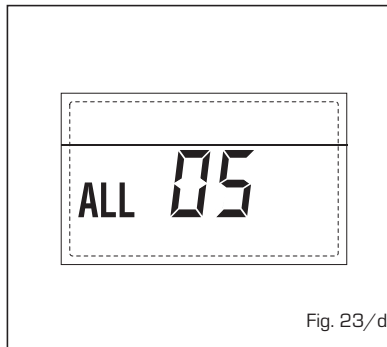



Fig. 23/d

- LOCKOUT ALARM 06 (fig. 23/e)

If a flame is not detected after a complete ignition cycle or for any other reason the flame is not detected, the boiler will stop and display "ALL 06".

Press the reset button  on the control panel (2) to restart the boiler.

Should the problem persist seek technical help.

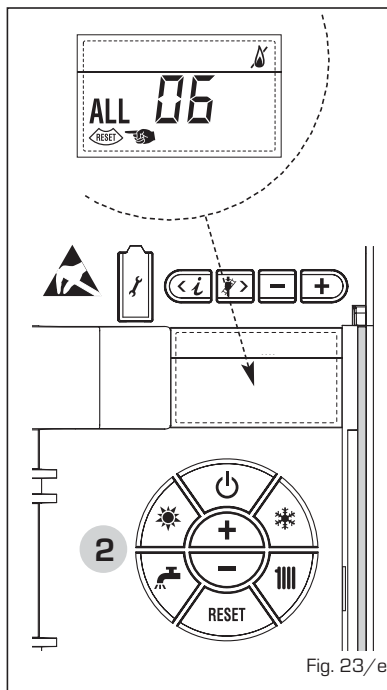



Fig. 23/e

- SAFETY THERMOSTAT

ALARM 07 (fig. 23/f)

If either the 100 degree stat or the heat exchanger safety stat open, the burner will turn off. If the stat closes within 1 minute, the boiler will resume operation. If the stat remains open for more than 1 minute the display will show "ALL 07".

Press the reset key  on the control

panel (2) to restart the boiler.

If the problem persists seek technical advice.

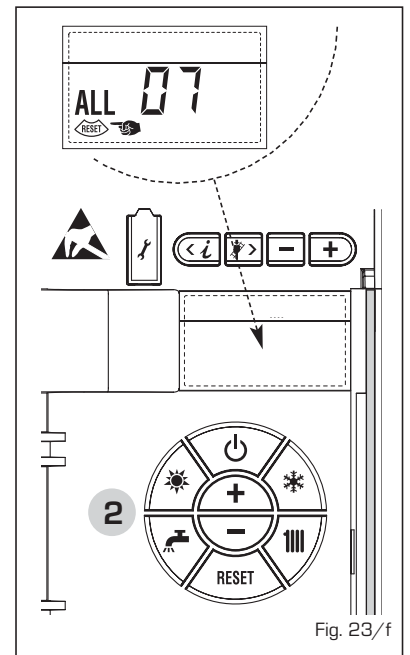

Fig. 23/f

- FLAME DETECTION

ERROR 08 (fig. 23/g)

If the flame control detects a flame when one should not be detected, the boiler will stop and display "ALL 08".

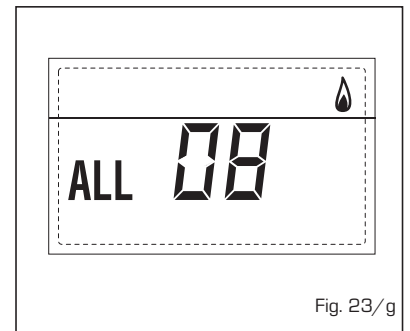

Fig. 23/g

- SYSTEM WATER CIRCULATION

ERROR 09 (fig. 23/h)

If the system flow switch detects inadequate circulation, the boiler will stop and the display will show "ALL 09". If the error persists for more than 1 minute, the boiler will stop and wait for 6 minutes

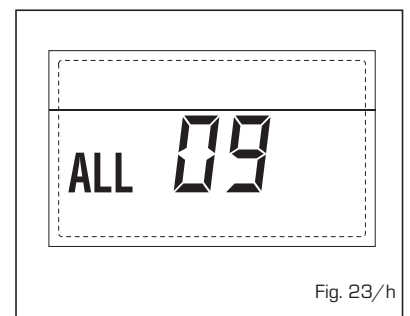
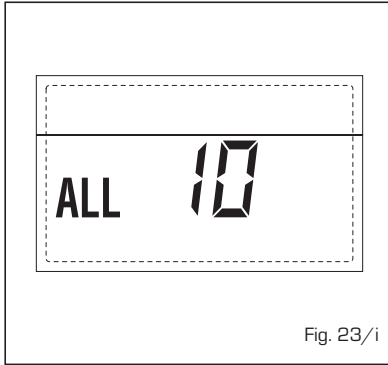

Fig. 23/h

tes. The boiler will then attempt to restart. Possible causes of this error are faulty or jammed pump, blocked Aqua Guard filter, closed flow or return valve, blocked heating system.

- D.H.W. SENSOR ERROR 10 (fig. 23/i)

When the D:H.W. sensor is open or short circuited, the display will show error "ALL 10". The boiler will function in central heating mode only.



- ACTIVATION OF THE EXHAUST FUMES THERMOSTAT ERROR 13 (Fig. 23/l) (Fig. 23/p)

The activation of this probe causes the boiler to stop and error message "ALL 13" to display.

Press the key  of the controls (2) to start up the boiler again.

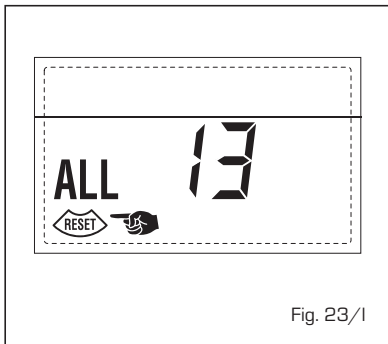

- EXHAUST FUMES THERMOSTAT ERROR 14 (fig. 23/m)

If the exhaust fumes thermostat is open or short circuit, the boiler will stop and display "ALL 14".

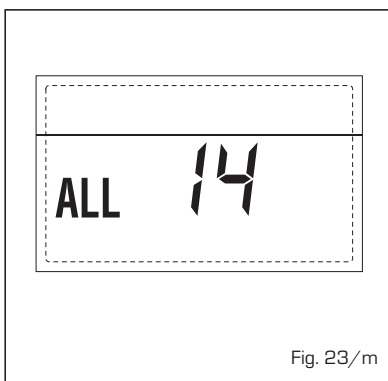

- FAN ERROR 15 (Fig. 23/n)

If the fan speed is not within the rated speed range, the display will show "ALL 15".

If the problem persists for more than two minutes the boiler will stop thirty minutes, after which it will attempt to resume operating.

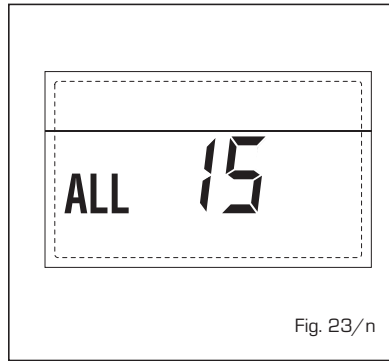

- SAFETY THERMOSTAT INTERVENTION FIRST MIXED ZONE "ALL 20" (fig. 23/p)

When the mixed zone board is connected to the boiler, a safety stat intervention switched the mixed zone pump, the mixed zone valve closes and the display indicates error ALL20. During this error the boiler functions normally.

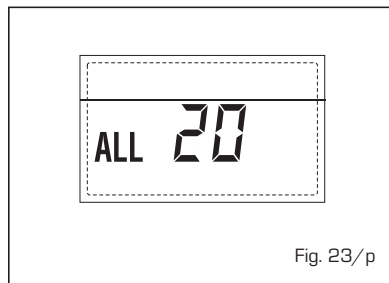

- DELIVERY PROBE FAILURE FIRST MIXED ZONE "ALL 21" (fig. 23/q)

When the mixed zone board is connected to the boiler, if the delivery probe sensor becomes open or short circuit the display will indicate ALL21. During this error the boiler will function normally.

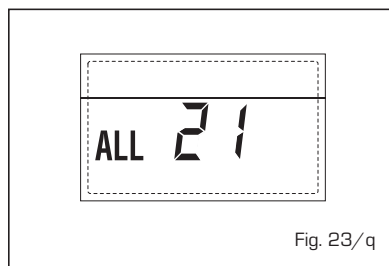

- SAFETY THERMOSTAT INTERVENTION SECOND MIXED ZONE "ALL 22" (fig. 23/r)

When the mixed zone board is connected to the boiler, intervention of the safety thermostat switches the pump, the mixed zone valve closes and the display indicates ALL22. During this error the boiler functions normally.

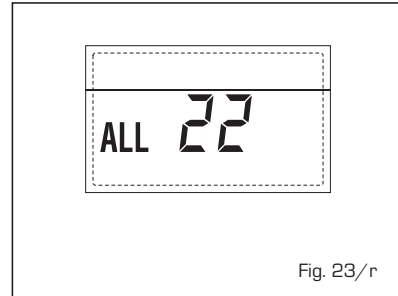

- DELIVERY PROBE FAILURE SECOND MIXED ZONE "ALL 23" (fig. 23/s)

When the mixed zone board is connected to the boiler, if the delivery probe sensor becomes open or short circuit the display will indicate ALL23. During this error the boiler will function normally.

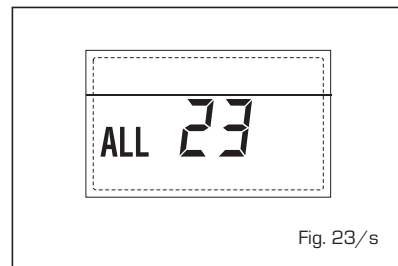

- NUMBER OF CONNECTED BOARDS ERROR "ALL 29" (fig. 23/y)

When the number of connected boards does not correspond to the number of boards set in the PCB (PAR 40) or there is a default of communication with it, on the display the indicates ALL 29 appears. During this error, the boiler continues to function normally.

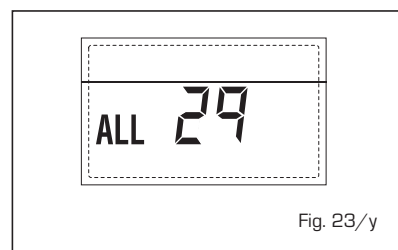

ATTENTION: If error "ALL 04" is displayed, the setting of PAR 2 is incorrect. Ensure that PAR 2 is set to value 3 (see section 3.3.1).

4.7 COMMISSIONING AND ROUTINE SERVICE

Commissioning and servicing can only be done by a qualified engineer.

Before any attempt is made to operate the boiler, ensure that the system and storage cylinder are filled, see section 2.4.2.

4.7.1 Commissioning

PLEASE NOTE: The combustion for this appliance has been checked, adjusted and preset at the factory for operation on the gas type defined on the appliance data plate. However, it is advisable to check for correct combustion as described in 4.3.2 having first checked:

- That the boiler has been installed in accordance with these instructions.
- The integrity of the flue system and the flue seals.
- The integrity of the boiler combustion circuit and the relevant seals

If the combustion reading is greater than the acceptable value AND the integrity of the complete flue system and combustion circuit seals have been verified and the inlet gas pressure (and gas rate) have been verified, contact Sime Service department.

The following procedure should be done after installation and gas purge and soundness/drop test have been made.

Ensure that the auto air vent on the pump and on top of the main heat exchanger are opened, turn the electrical supply on.

With the boiler on standby fill the system and pressurise to 1.5 bar.

Ensure that the pump has been manually rotated.

Open the gas Press the "☀" the boiler will light and heat the storage cylinder to the desired temperature.

Press the "❄", ensure that any timer or room thermostat are in the on position. The boiler will light and the system will be heated.

Set the controls to the required values as shown in the user guide.

Complete the Benchmark sheet enclosed in this manual.

Explain controls and operation to the user. Leave all documentation with the user.

4.8 ROUTINE SERVICE

To ensure continued efficient operation of the appliance, it is recommended that it is checked and serviced at regular intervals. The frequency of service will depend on the particular installation and conditions of usage, but in general once a year should be adequate, at this service the magnesium anode must be checked, see section 6.15. It is the law that a competent person such as a Gas Safe Register registered engineer,

must carry out any service work.

4.8.1 Combustion Check

Competence to carry out the check of combustion performance

PLEASE NOTE: BS 6798: 2009 Specification for installation and maintenance of gas-fired boilers of rated input not exceeding 70 kW net advises that:

- The person carrying out a combustion measurement should have been assessed as competent in the use of a flue gas analyser and the interpretation of the results;
- The flue gas analyser used should be one meeting the requirements of BS7927 or BS-EN50379-3 and be calibrated in accordance with the analyser manufacturers' requirements, and
- Competence can be demonstrated by satisfactory completion of the CPA1 ACS assessment, which covers the use of electronic portable combustion gas analysers in accordance with BS 7967, Parts 1 to 4.

Connect the flue gas analyzer to the flue gas sampling point as shown in the diagram and check combustion as described in 4.3.2.

During the test the boiler can be operated in "chimney sweep mode" see 4.3.2. The correct CO₂ reading can be found in section 1.3.

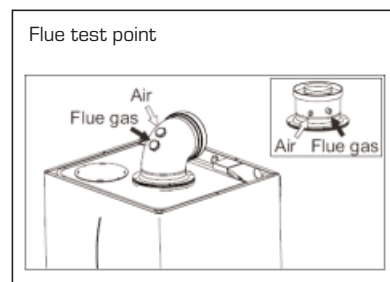

4.8.2 Burner inspection

Remove the burner as described in section 6.4.

Inspect the burner and if necessary clean using a soft brush, taking care not to damage the front insulation.

Check the Ignition/ionisation electrode, check the ignition spark gap (4 mm+/- 0.5 mm).

Check the ionisation electrode, check the distance from the burner (18.7 mm+/- 1 mm).

Before reassembly inspect all seals and replace as required.

4.8.3 Combustion Chamber

Remove any loose debris from the combu-

tion chamber using a soft brush and a vacuum cleaner.

Take care not to damage the rear insulation panel.

4.8.4 Condensate Trap

The condensate trap would not normally require removal during service, but can be checked whilst the burner assembly is removed.

Carefully pour water into the heat exchanger and check that it flows freely to the drain.

Should it require removal, firstly remove the two wire clips securing the condensate drain rubber pipe to the heat exchanger and the condensate trap.

Remove the pipe.

Remove the 1/2" nut securing the condensate trap to the combustion compartment. Disconnect the drain pipe from the trap. Clean the trap and refit in reverse order.

4.8.5 Flow Switch

The operation of the flow switch should be checked at each service.

Remove small cover retaining screw and remove the cover.

When the pump is running and water is flowing around the boiler, the actuator lifts releases the micro switch.

Check that the operation of the actuator. Ensure that it is free and that it lifts and returns.

If necessary lubricate the pivot point of the actuator.

Isolate the boiler:

Drain it using the drain provided.

Remove the micro switch by carefully pulling it forward off its mounting pins.

Remove the screw securing the mounting plate, then pull off the plate.

Pull out the actuator pin.

Lubricate the centre "O" ring.

Refit the actuator ensuring that the flat side of the round section is to the bottom.

Re-assemble remaining parts.

Service Record

It is recommended that your heating system is serviced regularly and that the appropriate Service Interval Record is completed.

Service Provider

Before completing the appropriate Service Record below, please ensure you have carried out the service as described in the manufacturer's instructions.

Always use the manufacturer's specified spare part when replacing controls.

Service 1 Date: _____
Engineer Name: _____
Company Name: _____
Telephone No. _____
Gas Safe Register No. _____
Comments: _____
Signature: _____

Service 2 Date: _____
Engineer Name: _____
Company Name: _____
Telephone No. _____
Gas Safe Register No. _____
Comments: _____
Signature: _____

Service 3 Date: _____
Engineer Name: _____
Company Name: _____
Telephone No. _____
Gas Safe Register No. _____
Comments: _____
Signature: _____

Service 4 Date: _____
Engineer Name: _____
Company Name: _____
Telephone No. _____
Gas Safe Register No. _____
Comments: _____
Signature: _____

Service 5 Date: _____
Engineer Name: _____
Company Name: _____
Telephone No. _____
Gas Safe Register No. _____
Comments: _____
Signature: _____

Service 6 Date: _____
Engineer Name: _____
Company Name: _____
Telephone No. _____
Operative ID No. _____
Comments: _____
Signature: _____

Service 7 Date: _____
Engineer Name: _____
Company Name: _____
Telephone No. _____
Gas Safe Register No. _____
Comments: _____
Signature: _____

Service 8 Date: _____
Engineer Name: _____
Company Name: _____
Telephone No. _____
Gas Safe Register No. _____
Comments: _____
Signature: _____

Service 9 Date: _____
Engineer Name: _____
Company Name: _____
Telephone No. _____
Gas Safe Register No. _____
Comments: _____
Signature: _____

Service 10 Date: _____
Engineer Name: _____
Company Name: _____
Telephone No. _____
Gas Safe Register No. _____
Comments: _____
Signature: _____

SERVICE RECORD

It is recommended that your hot water system is serviced regularly and that the appropriate Service Record is completed.

Service Provider

Before completing the appropriate Service Record below, please ensure you have carried out the service as described in the manufacturer's instructions.

SERVICE 1 Date

Engineer Name

Company Name

Telephone Number

Comments

Signature

SERVICE 2 Date

Engineer Name

Company Name

Telephone Number

Comments

Signature

SERVICE 3 Date

Engineer Name

Company Name

Telephone Number

Comments

Signature

SERVICE 4 Date

Engineer Name

Company Name

Telephone Number

Comments

Signature

SERVICE 5 Date

Engineer Name

Company Name

Telephone Number

Comments

Signature

SERVICE 6 Date

Engineer Name

Company Name

Telephone Number

Comments

Signature

SERVICE 7 Date

Engineer Name

Company Name

Telephone Number

Comments

Signature

SERVICE 8 Date

Engineer Name

Company Name

Telephone Number

Comments

Signature

SERVICE 9 Date

Engineer Name

Company Name

Telephone Number

Comments

Signature

SERVICE 10 Date

Engineer Name

Company Name

Telephone Number

Comments

Signature

5 FAULT FINDING

If an electrical fault occurs on the appliance the preliminary electrical system checks must be carried out first.

When any service or replacement of electrical components which has required the breaking and re-making of electrical connections has taken place, the following tests must be repeated:

- earth continuity;
- short circuit;
- polarity;
- resistance to earth.

5.1 EARTH CONTINUITY CHECK

Appliances must be electrically disconnected, meter set on Ω (ohm) x 1 scale and adjust zero if necessary. Test leads from any appliance earth point (e.g. inside control box) see wiring diagrams (section 7) to earth pin on plug.

Resistance should be less than 1 Ω (ohm). If the resistance is greater than 1 Ω (ohm) check all earth wires for continuity and all contacts are clean and tight. If the resistance to earth is still greater than 1 Ω (ohm) then this should be investigated further.

5.2 SHORT CIRCUIT CHECK

Switches turned FULL ON - meter set on Ω (ohms) x 1 scale. Test leads from L to N on appliance terminal block, if meter reads 0 then there is a short circuit.

Meter set on Ω (ohm) x 100 scale. Repeat it with leads from L to E. If meter reads less than infinity (∞) there is a fault.

NOTE: Should it be found that the fuse has failed but no fault is indicated, a detailed continuity check (i.e. by disconnecting and checking each component) is required to trace the faulty component.

It is possible that a fault could occur as a result of local burning/arcing but no fault could be found under test. However, a detailed visual inspection should reveal evidence of burning around the fault.

5.3 POLARITY CHECK

Appliance reconnected to mains supply and meter set on 300 V ac scale. Test at appliance terminal block.

- Test leads from L to N meter reads

approx.: 240 V ac.

- Test leads from L to E " * " meter reads approx. 240 V ac.
- Test leads from N to E " * " meter reads from 0 to 15 V ac.

5.4 RESISTANCE TO EARTH CHECK

Appliance must be disconnected from main supply and meter on Ω (ohm) x 100 scale.

All switches including thermostat on test leads from L to E - if meter reads other than infinity (∞) there is a fault which should be isolated.

A detailed continuity check is required to trace the faulty component.

IMPORTANT:

These series of checks are the first electrical checks to be carried out during a fault finding procedure. On completion of the service/fault finding task which has required the breaking and remaking of electrical connections then the checks 5.1 Earth continuity, 5.3 Polarity and 5.4 Resistance to earth must be repeated.

6 REPLACEMENT OF PARTS

6.1 EXPANSION VESSEL

- Turn off power supply
- Remove boiler cover, see 4.4.
- Isolate flow and return valves
- Drain boiler using fitted drain vent
- Disconnect expansion pipe
- Loosen top fixing screw and remove lower expansion vessel locking nut.
- Remove vessel and transfer the fixing bracket to the new vessel.
- Check new vessel for correct pressure 1- 1.25 bar
- Refit in reverse order.

6.2 IGNITION ELECTRODE

- Turn off power supply
- Remove boiler cover see 4.4
- Remove sealed chamber cover
- Disconnect electrode from ignition transformer
- Pull lead through grommet
- Remove electrode fixing screw
- Carefully remove electrode from burner
- Replace in reverse order.

6.3 IONISATION ELECTRODE

- Turn off power supply
- Remove boiler cover see 4.4
- Remove sealed chamber cover
- Disconnect electrode
- Remove electrode fixing screw
- Carefully remove electrode from burner
- Replace in reverse order

6.4 MAIN BURNER

- Turn off power supply
- Isolate gas supply
- Remove boiler cover
- Remove sealed chamber cover
- Disconnect gas connection at injector
- Disconnect air sensing tube
- Disconnect two plugs to fan
- Remove ignition electrode 6.3
- Disconnect ionisation electrode
- Remove 6 x 10mm nuts securing burner to heat exchanger
- Carefully lift out burner assembly
- Refit in reverse order
- Test for gas tightness.

6.5 FAN ASSEMBLY

- Remove burner assembly as described in 6.4
- Remove 2 x 8mm bolts and loosen 2 x 8mm securing fan to burner assembly
- Remove restrictor plate and fit to new fan
- Refit in reverse order
- Recommission boiler
- Test for gas soundness.

6.6 MAIN HEAT EXCHANGER

- Turn off power supply

- Isolate gas supply
- Isolate flow and return valves
- Drain boiler using drain vent
- Remove burner assembly as described in 6.4
- Remove flue connection
- Disconnect flue sensor
- Disconnect limit stat
- Remove condensate drain connections
- Disconnect flow and return connections
- Remove two fixing brackets
- Lift out heat exchanger
- Refit in reverse order
- Recommission boiler
- Test for gas tightness.

6.7 FLUE SENSOR

- Turn off power supply
- Remove cover
- Remove sealed chamber cover
- Disconnect flue sensor
- Unscrew sensor
- Replace in reverse order.

6.8 100° SAFETY STAT

- Turn off power supply
- Remove cover
- Remove sealed chamber cover
- Disconnect 100° safety stat
- Remove fixing screws
- Refit in reverse order.

6.9 HEATING THERMISTOR (SM SENSOR)



- Turn off power supply
- Remove cover
- Remove sealed chamber cover.

- Isolate flow and return valves
- Drain boiler using drain vent
- Disconnect thermistor
- Unscrew thermistor (catch any water lost)
- Refit in reverse.

6.10 D.H.W. THERMISTOR (SB) SENSOR

- Turn off power supply
- Remove cover see 4.4
- Isolate cold water supply valve
- Drain the cylinder
- Disconnect thermistor
- Unscrew thermistor (catch any water lost)
- Refit in reverse.

6.11 GAS VALVE

- Turn off power supply
- Isolate gas supply
- Remove boiler cover see 4.4
- Disconnect wiring from gas valve
- Disconnect sensing tube
- Remove gas valve
- Refit in reverse order ensuring seals are replaced as required
- Setting the gas valve procedure:
 1. Open the downstream test point [4 fig. 25] and connect a digital manometer set on the mmH2O scale. Ensure the meter is zeroed.
 2. Fully open the SHUTTER [5 fig. 25] turn anti clockwise
 3. Press and hold the  button for 10 seconds to enter "chimney sweep"  will appear flashing on

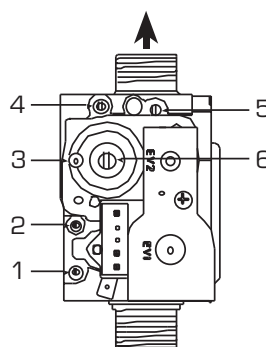

KEY





- 1 Upstream pressure intake
- 2 Intermediate pressure intake
- 3 Air signal inlet (VENT)
- 4 Downstream pressure intake
- 5 Capacity step
- 6 OFF-SET

TABLE 1

Gas	Model	Minimum output	Maximum output	CO2 % +/- 0.3	Ratio Less than
		SHUTTER fully open Adjust OFF - SET mmH ₂ O	OFF-SET adjusted Adjust SHUTTER mmH ₂ O		
Methane	25/55HE	5.6	62.2	9.0	0.004
	30/55HE	6.6	77.5	9.0	0.004
LPG	25/55HE	9.2	70.4	10.0	0.004
	30/55HE	9.7	85.7	10.0	0.004

Fig. 25

the display and the boiler runs at minimum power.

4. With the SHUTTER (5 fig. 25) fully open, adjust the OFF-SET (6 fig. 25) to obtain the first pressure value shown in Table 1 - OFF-SET column, ensure that the value is correct for the gas being used. If these figure are not obtainable (low), confirm that the working inlet gas pressure is correct.
 5. Press the  button, the boiler will increase to maximum power.
 6. Close the SHUTTER (5 fig. 25) to obtain the second pressure reading indicated in Table 1 - SHUTTER column.
 7. Once these adjustments have been obtained, a combustion check (flue gas analysis) must be done. See section 4.3.2.
 8. Press the  button to return the boiler to minimum output.
 9. Now connect the flue gas analyser.
 10. Check the analyzer CO₂/Ratio and compare to values reported in Table 1. Make any final adjustments by small adjustments to the OFF-SET screw (6 fig. 25), allow time for the analyser to respond to the adjustments.
 11. Press the  button, the boiler will move to maximum output. Verify that the CO₂/Ratio. Make any final adjustments by small adjustments to the SHUTTER (5 fig. 25) allow time for the analyser to respond.
 12. Recheck the low reading by pressing the  button.
 13. Press the Standby  key to exit.
 14. Remove the manometer and analyser, close the test points, and check for tightness.
- Check for gas tightness.

6.12 PRINTED CIRCUIT BOARD (PCB)

- Isolate from power supply
- Remove screw securing control panel
- Lower panel to horizontal position
- Remove PCB covers
- Disconnect all wiring
- Remove PCB fixing screws
- Ensure any PCB links are matched to old board
- Reset PAR 1 and PAR 2 as per the table 3.3.1
- Refit in reverse order
- Recommission boiler.

6.13 PUMP MOTOR

- Turn off power supply
- Remove boiler cover
- Isolate flow and return valves
- Drain boiler using drain vent
- Remove plug connection
- Remove 4 x fixing screws, catch any lost water

- Refit in reverse using new gasket.

6.14 DHW EXPANSION VESSEL

- Turn off power supply
- Remove boiler covers
- Isolate DHW supply
- Drain the cylinder
- Disconnect the DHW expansion vessel
- Check the pressure of the new cylinder (3 bar)
- Refit in reverse order

6.15 SACRIFICIAL MAGNESIUM ANODE

This is located in the base of the cylinder.

- Turn off the power supply
- Turn off the domestic water supply to the boiler.
- Open a DHW tap.
- Connect a suitable drain hose to the cylinder drain cock.
- Open the drain cock.
- When fully drained, remove and examine the anode.
- If required replace the anode.
- Refit in reverse order
- See section 2.4.2 for refilling instructions.

7 EXPLODED VIEWS

COD. **3830050/617**

TYPE **MURELLE EV HE 25-55/30-55**

DATE **18.06.2009**

PAGE **1/4**

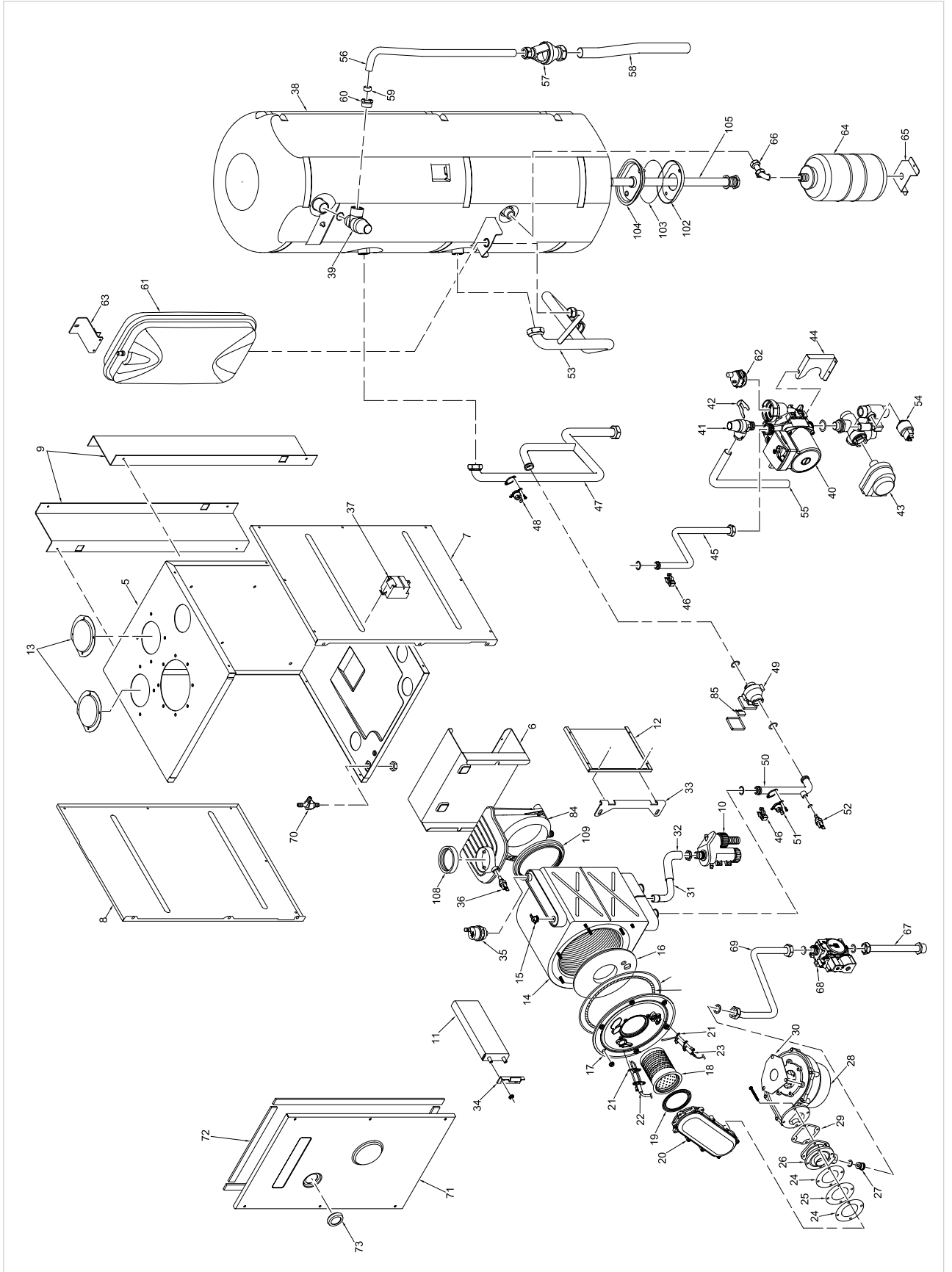

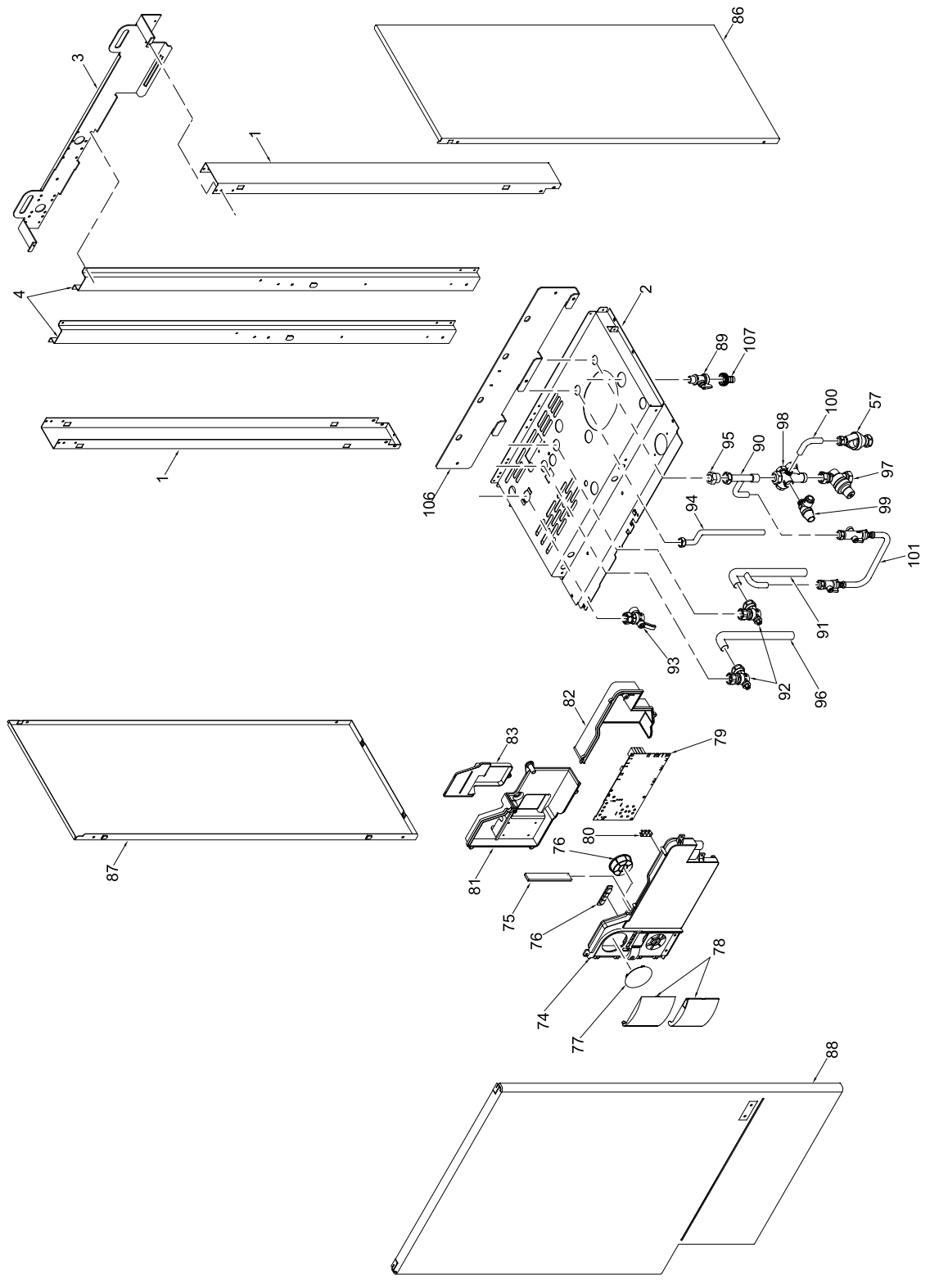

COD. **3830050/617**

TYPE

MURELLE EV HE 25-55 /30-55

DATE

18.06.2009

PAGE

3/4

POSITION	CODE	DESCRIPTION	MODEL	NOTE
1	6138558	Right/left hand side frame part		
2	6138895	Frame assembly lower side		
3	6138711	Frame assembly upper support		
4	6256714	Sealed chamber rear support		
5	6266036	Sealed chamber rear panel		25/55
5 A	6266037	Sealed chamber rear panel		30/55
6	6010810	Smoke chamber fixing panel		25/55
6 A	6010811	Smoke chamber fixing panel		30/55
7	6266123	Sealed chamber right hand side panel		
8	6266122	Sealed chamber left hand side panel		
9	6267103	Sealed chamber fixing bracket		
10	6277204	Water trap		
11	6010813	Main exchanger L.H. side support		
12	6010815	Main exchanger R.H. side support		
13	6029100	Blind inlet flange		
14	5188316	Complete main exchanger		25/55
14 A	5188317	Complete main exchanger		30/55
15	6146721	Limit stat		
16	6269007	Main exchanger door insulation		
17	6278852	Main exchanger door		
18	6278351	Burner		
19	6174817	Gasket for burner flange		
20	6278802	Air-gas hose		
21	6174809	Gasket for ignition electrode		
22	6221632	Ignition electrode		
23	6221623	Ionisation electrode		
24	6174812	Mixer/hose gasket		
25	6239206	Mixer closing plate		
26	6274306	Air/gas mixer		
27	6274121	Burner nozzle ø 6,00 natural gas		
27 A	6274120	Main burner nozzle Ø 4,04 LPG		
28	6261408	Fan		
29	6174816	Gasket for fan flange		
30	6028647	Air diaphragm		
31	6034150	Condensate drainage pipe		
32	6034151	Condensate drainage pipe		
33	6010812	Main exchanger R.H. fixing bracket		25/55
34	6010814	Main exchanger fixing bracket		

POSITION	CODE	DESCRIPTION	MODEL	NOTE
35	6013102	Automatic air vent 1/4"		
36	6277131	Probe NTC D.4X47		
37	6098315	Ignition transformer		
38	5194303	Insulated stainless steel tank 55 l		
39	6029002	Pressure relief valve 1/2" - 7 bar		
40	6124818	Circulating pump Grundfos UPS 15-60		
41	6040209	Pressure relief valve		
42	6226621	Pressure relief valve fixing spring		
43	6087304	Motor for Honeywell diverting valve		
44	6073318	Circulating pump fixing bracket		
45	6277928	Pipe connecting pump-exchanger		25/55
45 A	6277929	Pipe connecting pump-exchanger		30/55
46	6226601	Spring for heat exchanger connection		
47	6216233	C.H. system flow pipe		
47 A	6216234	C.H. system flow pipe		25/55
48	6146700	Limit stat auto reset		30/55
49	6149303	Flow water switch		
49 A	6149309	Flow water switch		25/55
50	6277713	Main exchanger outlet pipe		30/55
51	6146701	100°C safety stat		
52	6231351	Plunged sensor		
53	6216016	D.H.W. cylinder return pipe		
54	6273603	Water pressure transducer		
55	6157634	Pressure relief valve drain pipe		
56	6157633	Pressure relief valve drain pipe		
57	6269405	Tundish		
58	6157635	Tundish drain pipe		
59	6100202	Ogive for pipe Ø 15		
60	6168401	Locking nut for pipe Ø 15		
61	5183722	Rectang. expansion vessel 10 l.		
62	6013181	Automatic air vent		
63	6267109	D.H.W. expans. vessel locking bracket		
64	6245102	Sanitary D.H.W. tank - 2.5 L.		
65	6073312	Expansion vessel support		
66	6227644	D.H.W. expansion vessel connect. pipe		
67	6226878	Gas inlet pipe		
68	6243823	Gas valve type		
69	6277413	Pipe connecting gas valve-mixer		

* Recommended stock parts - Componenti da tenere a scorta

Fonderie Sime S.p.A. - Via Garbo, 27 - 37045 Legnago (Verona) - Tel. +39-0442-631111 - Fax +39-0442-631292 - www.sime.it

POSITION	CODE	DESCRIPTION	MODEL	NOTE
70	6280500	3-ways junct. with press. test nipple		
71	6228865	Sealed chamber front panel		
72	5192204	Gasket for sealed chamber		
73	6001210	Peephole		
74	6304700	Control panel		
75	6305160	Guidelight with led		
76	6305120	Kit Rubber button		
77	6247327	Cap for time programmer		
78	6304890	Flap door assembly		
79	6301495	Main PCB		
80	2211610	Earth faston		
81	6305000	Cover		
82	6305010	connection cover		
83	6305020	Time programmer cover		
84	6278701	Smoke chamber		
85	6131401	Microswitch for flowmeter		
86	6242117	Casing right hand side panel		
87	6242217	Casing left hand side panel		
88	6304232	Casing front panel		
89	6179100	Drain cock 3/8"		
90	6157630	Cold water inlet pipe		
91	6142427	C.H. flow pipe		
92	6177505	Ball cock 3/4" x 22		
93	6177530	Gas cock 3/4" F x 15		
94	6142572	Pipe connecting jig		
95	6120519	Adapter		
96	6142426	C.H. return pipe		
97	6037580	Water pressure reducer 3/4"		
98	6265850	5 ways water collector		
99	6040208	Pressure relief valve		
100	6157628	PRV drain pipe		
101	5199100	Filling Loop		
102	6258312	D.H.W. cylinder counterflange		
103	6052705	Gasket for D.H.W. cylinder flange		
104	6258311	D.H.W. cylinder flange		
105	6072708	Magnesium anode + plug 3/4" + OR		
106	6215211	Hanging bracket		
107	6179200	Holder complete with locking nut		

POSITION	CODE	DESCRIPTION	MODEL	NOTE
108	6248851	Smoke chamber outlet gasket		
109	6248856	Smoke chamber / heat exchanger gasket		
110	6228623	Diverter valve spring		
111	6146603	Filling cock 5197001 group		
	5197152	Complete control panel		
	5197002	Brass hydraulic group		
	6316230	3 pole cable connector		
	6299991	4 pole cable connector		
	6316231	5+4 pole cable connector		
	6316276	9 pole Stocko connector		
	6316233	14 pole cable connector		
	6316200	Connector 2 poli		
	6316202	Connector 4 poli		
	6316203	Connector 4 poli		
	6316204	Connector 8 poli		
	6285001	Ionisation lead L= 1200		
	5191830	Water press.reduc.-press.relief valve		
	6281534	Gaskets kit		
	5185130	Conversion kit to LPG		
	6231330	Temperature sensor L=1120		
		Products reference:		
	8102750:	Murelle EV HE 25-55 GB		
	8102752:	Murelle EV HE 30-55 GB		
		Check the correspondence with the boiler data plate.		

Dealing with Condensate

Five suitable drainage points

1. Internal drain stack pipe
2. Waste water pipe *
3. External drain or gully *
4. Rainwater hoppers that carry both rain water and foul water *
5. Purpose-made soakaways

* Care should be taken not to contaminate any "Grey Water Systems"

Pipework

Condensate pipework should be plastic, same as used for standard wastewater plumbing.

Similarly the drainage system where the condensate discharges to should also be resistant to the acidic condensate.

Connection to the internal trap in the boiler can be achieved by using a 20mm solvent weld socket.

Pipework should be kept as short as possible.

External runs should be avoided, but when necessary be a minimum of 3 meters in 32mm diameter pipework and lagged to avoid freezing, this also applies to pipe runs in unheated areas such as garages.

To reduce the possibility of condensate being trapped in the pipe, the number of bends should be kept to a minimum.

Pipework must be angled down from the boiler with a fall of at least 2.5.

The pipework must be supported at a distance of 0.5m for inclined runs and 1.0m for vertical runs.

Condensate traps

Where the condensate drain is not sealed to the discharge connection a trap will be required. The water seal should be 38mm or more for external discharge and 75mm or more for internal discharge. When connecting to a external stack the trap should be located within the building.

Stack Pipes

Condensate connections should be at least 450mm above any bend at the bottom of a stack pipe in a single or multi-story dwelling up to 3 storeys.

There are specific requirements when connecting to a stack pipe serving multi-storey buildings greater than 3 storeys.

All connections to stack pipes should avoid cross flow between other Branch pipes.

Soakaways

Any soakaways have to be purpose-made and located as close to the boiler as possible, but clear of the buildings foundations and any buried services. The best option is to purchase a soakaway from a drainage manufacturer and install it to the manufacturers recommendation.



Sime Ltd

1a Blue Ridge Park
Thunderhead Ridge
Glasshoughton, Castleford, WF10 4UA

Phone: 0845 9011114

Fax: 0845 9011115

www.sime.ltd.uk

Email: enquiries@sime.ltd.uk