

FOCAL
POINT
FIRES_{plc}

Excelsior

16" Taper Inset

Fuel Effect Gas Fire
Manual or Remote control

INSTALLATION, SERVICING
AND USER INSTRUCTIONS

All instructions must be handed to the user for safekeeping

Revision A 02/02

Country(s) of destination: GB, IE

Focal Point Fires plc, Avon Trading Park, Christchurch, Dorset BH23 2BT

☎: (01202) 499330

Fax: (01202) 499326

www.focalpointfires.co.uk

e-mail: sales@focalpointfires.co.uk



INSTALLATION INSTRUCTIONS

Preliminary Notes Before Installation

This appliance is an Inset Decorative Fuel Effect appliance which provides radiant warmth utilising the latest type burner technology.

The fire is designed to fit various types of fireplaces and natural draught flues as listed in the Installation Requirements.

The appliance must be installed by a competent person in accordance with Gas Safety (Installation and Use) Regulations 1998. It is strongly recommended that a CORGI registered engineer be used for this purpose.

Read all these instructions before commencing installation.

This appliance must be installed in accordance with the rules in force and only used in a sufficiently ventilated space.

The appliance is designed for installation on to a non-combustible hearth of at least 300mm depth.

This appliance is factory set for operation on the gas type, and at the pressure stated on the appliance data plate.

This appliance is available in either a manual control version, or a battery powered remote control version, with a number of fuel effect options. These instructions cover both control options, and all fuel effect options. See the relevant sections of these instructions for further details.

<i>Section</i>	<i>Contents</i>	<i>Page No.</i>	<i>Section</i>	<i>Contents</i>	<i>Page No.</i>
1.0	Important Notes	1	8.0	Fuel Bed Layout (coal versions)	5
2.0	Appliance Data	2	8.1	Fuel Bed Layout (pebble versions)	7
3.0	Installation Requirements	2	8.2	Fuel Bed Layout (log versions)	8
4.0	Site Requirements	3	9.0	Fitting the decorative Front	8
5.0	Ventilation	4	10.0	Testing & Commissioning	9
6.0	Unpacking the Appliance	4	10.1	Operating the fire (manual versions)	10
6.1	Component Checklist	5	10.2	Operating the fire (remote versions)	10
7.0	Installation of the Appliance	5	11.0	Servicing	12
			12.0	Troubleshooting Guide	14
				User Instructions	

1.0 IMPORTANT NOTES

This fire is an Inset Live Fuel Effect Gas Fire providing radiant warmth. It is designed to operate on Natural Gas only. See Data Plate on appliance.

It is the LAW that all gas appliances and fittings are installed by a competent person (such as a CORGI registered fitter) and in accordance with the Gas Safety (Installation and Use) Regulations 1998, the relevant British Standards for Installation, Codes of Practice and in accordance with the Manufacturers' Instructions. The installation shall also be carried out in accordance with the following regulations:

The Building Regulations issued by the Department of the Environment, the Building Standards (Scotland) (Consolidation) Regulations issued by the Scottish Development Department.

BS 5871 part 2

BS 5440 part 1

BS 8303

BS 1251

BS 6891

BS 6461 part 1

Note - For Republic of Ireland, reference should be made to the relevant standards governing installation, particularly in regard to flue sizing and ventilation. See IS813, ICP3, IS327 and any other rules in force.

Failure to comply with these regulations could lead to prosecution and deem the warranty invalid.

This appliance must be installed in accordance with the rules in force and used only in a sufficiently ventilated space. Consult all instructions before installation and use of this appliance. This appliance is intended for decorative purposes.

This appliance is free from any asbestos material. Refractories and coal bed are constructed from ceramic fibre.

Note : Remote control models only - This appliance features a battery-operated remote control system, and under normal usage will need new batteries approximately every twelve months.

Remote control Handset requirements - 1 x 'PP3' type (9 volt)

Receiver/motor unit requirements - 4 x 'AA' type (1.5 volt)

Refer to the appropriate section of these instructions for details of how to change the batteries.

2.0

APPLIANCE DATA

	<u>Manual Control Version</u>	<u>Remote Control Version</u>
Gas Group	G20 Natural Gas CAT I2H	G20 Natural Gas CAT I2H
Inlet Pressure	20 mbar	20 mbar
Max Energy Input (gross)	6.8 kW	6.8 kW
Min Energy Input (gross)	3.5 kW	3.5 kW
Pilot Energy Input (gross)	210 W	210 W
Setting Pressure (cold)	15.8 mbar (+/- 0.75mbar)	15.8 mbar (+/- 0.75mbar)
Main Injector Burner	Stereo size 81/Bray cat. 82/420	Stereo size 81/Bray cat. 82/420
Gas Inlet Connection	8mm Inlet Restrictor Elbow	8mm Inlet Restrictor Elbow
Gas Control Valve	Dungs BM 733	Mertik Maxitrol GV34 Series
Ignition	Integral Piezo spark	Integral Piezo spark
Spark Gap	3.5 to 4.5mm	3.5 to 4.5mm
Weight	10 Kg	11 Kg

Please see Data Badge affixed to appliance for current data.

This appliance is for use only with the gas type, and at the pressure stated on the appliance Data Badge, and is for decorative purposes.

3.0

INSTALLATION REQUIREMENTS

This appliance MUST NOT be installed into a room containing a bath or shower, or where steam may be present. The fire has been designed to fit into a builders' opening or fireplace conforming to BS 1251 (and meeting certain dimensional requirements), or a suitable flue box complying with the constructional requirements of BS 715. The flue box must be installed onto a suitable non-combustible insulating surface at least 12mm thick, covering the entire base area of the box.

The flue must have an effective height of at least three meters, as measured from the hearth to the top of the flue. Any flue damper plates or restrictors should be removed and no other restriction fitted to the flue. Where removal is not practical, the restriction must be fixed in the fully open position.

A natural draught flue system is required, and if previously used for solid fuel or oil burning, the flue and chimney must be swept prior to appliance installation. Pre-cast flues must be checked for mortar fangs and correct installation of joints, flue sections in loft space and terminals. The flue must be checked before installation by using a smoke pellet or similar to ensure proper draw and that leakage is not evident at any joints. Repair and re-test as necessary before the appliance is installed.

The flue must be connected to only one fireplace, and the flue must not vent more than one appliance (i.e. not shared with a gas back boiler). There must be no opening in the flue apart from the one that the appliance is installed into, and the one venting the gases into the air. A suitable terminal may be fitted, such as class GC1, as regulations allow.

This appliance has been tested for use with circular flues of a minimum internal diameter of 175mm.

The flue termination (cowl) must be of a type suitable for use with an inset Decorative Fuel Effect Fire BS5871 part 3 contains further details.

4.0 SITE REQUIREMENTS

The fireplace opening should be inspected and repairs made where necessary. Any chair brick may be left in place.

The opening WIDTH and HEIGHT dimensions should be between 400mm and 440mm wide, and 550mm to 575mm high.

Opening DEPTH should be 220mm or greater. Opening DEPTHS include any plaster or infill panels which form part of the installation.

This appliance requires a natural draught flue system which may be one of the following;

225mm x 225mm (9in x 9in) brick or stone.

175mm (7in) minimum diameter lined brick or stone.

175mm (7in) minimum diameter twin wall flue conforming to BS 715.

Any existing under grate draught device must be sealed off.

The opening wall must be non-combustible.

The appliance requires a hearth with non-combustible surface of at least 12mm thick. The top surface must be at least 50mm above the surrounding floor level, or be surrounded by a raised edge or fender 50mm high.

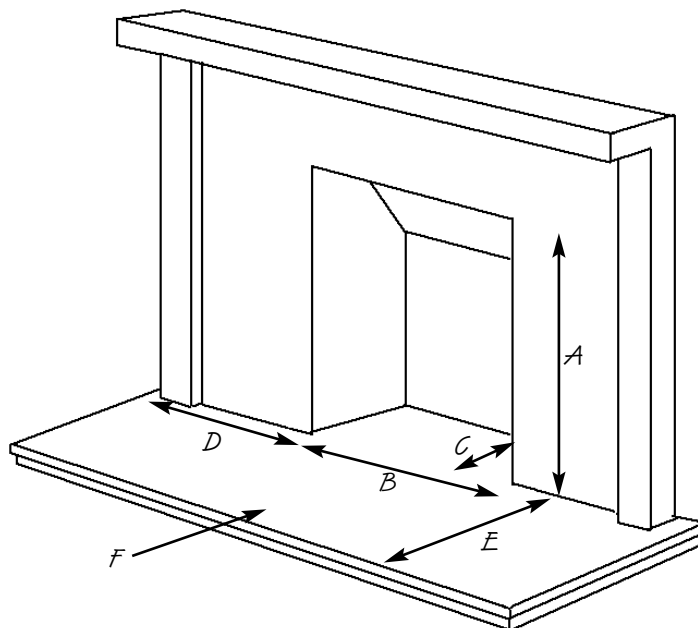

- A. Opening height: 550mm min/575 mm max.
- B. Opening width: 400mm min/440mm max.
- C. Mounting depth: 220mm
- D. Hearth must extend minimum of 150mm either side of the opening.
- E. Hearth must extend minimum of 300mm in front of the opening.
- F. Non-combustible hearth must be a minimum of 50mm in height, or be surrounded by 50mm high fender.

4.0 SITE REQUIREMENTS (continued)

Any type of fire surround used with this appliance must be adequately sealed to the wall and floor.

A combustible shelf may be fixed to the wall above the fire, providing that it complies with the dimensions given below.

<i>Maximum depth of shelf</i>	<i>Minimum distance from finished hearth surface to underside of shelf</i>
100mm (4in)	745mm (29 1/4 in)
150mm (6in)	845mm (33 1/4 in)
203mm (8in)	895mm (35 1/4 in)

A non-combustible shelf may be fitted to within 10mm of the top edge of the fireplace opening.

Combustible materials, such as wood, may be fitted to within 100mm (4in) of either side of the fireplace opening, providing the forward projection does not exceed 100mm (4in).

Any combustible side walls must be at least 500mm to the side of the radiant heat source.

As with all heating appliances, any decorations, soft furnishings, and wall coverings (i.e. flock, blown vinyl and embossed paper) positioned too close to the appliance may discolour or scorch.

5.0 VENTILATION

No purpose provided ventilation is normally required for this appliance. The requirements of other appliances operating in the same room or space must be taken into consideration when assessing ventilation.

If spillage is detected when commissioning the appliance then amongst other problems there may be insufficient natural ventilation for the correct operation of the flue. This is potentially a greater problem should the property be of modern nature. If the appliance does not spill with windows open but does with windows closed, this proves that lack of ventilation is the problem, if not, it will be the flue at fault. Installation of an air brick is the best solution. Any ventilation fitted must comply with BS 5871 part 2 and BS 5440 part 2. Ventilation located underneath or within the immediate vicinity of the fire MUST NOT be used as it may adversely affect the performance of the O.D.S. system.

Spillage detected during commissioning is almost always a result of poor flue performance, which cannot be corrected by any amount of ventilation.

For Republic of Ireland ventilation may be required, see IS 813, ICP3, IS 327, and any other rules in force.

6.0 UNPACKING THE APPLIANCE

Stand the carton right way up, cut the strapping bands and remove the top end cap.

Read all the instructions before continuing to unpack or install this appliance.

Remove the box containing the cast front fret, and the bag containing the coals. Remove the cardboard packing pieces, and any bags containing other fittings or parts.

When all loose parts have been removed, the outer sleeve may be lifted off to reveal the appliance.

Check that the components supplied correlate with the checklist given in section 6.1.

Please dispose of the packaging materials at your local recycling centre.

6.1 COMPONENT CHECKLIST

QUANTITY	DESCRIPTION
1	Burner tray assembly.
1	Firefront with separate ashpan cover, one of several designs and finishes.
1	Moulded ceramic fibre combustion matrix.
16	Individual ceramic coals (coal effect option only)
16	Individual ceramic pebbles (pebble effect option only)
1	Moulded ceramic front coal strip (coal effect option only)
1	Moulded ceramic front strip (pebble effect option only)
1	Set of manufacturers instructions and warranty card.
1	Remote control handset (remote control option only)
1	Pack of batteries (1 x 'PP3', 4 x 'AA') (remote control option only)
1	Screw and rawlplug pack

7.0 INSTALLATION OF APPLIANCE

Note: Ensure that the gas supply is isolated before commencing installation of the appliance.

Smoke test the flue to ensure proper draw and that there are no leaks present.

Locate the gas supply point. This appliance is suitable for all gas connections, including those concealed behind the opening.

Important Note: Check that the thermocouple connection nut into the rear of the valve is secure.

Place the appliance into the shaped firebrick, ensuring it does not protrude forward of the fireplace opening. Mark the location of the front support of the tray. Remove the tray and drill the two marked holes with an appropriate masonry bit. Place fibre rawl plugs into the holes. Remove the front support from the appliance by unscrewing from the two front legs. Position the front foot in the over the holes and secure the front support using suitable screws into the prepared holes. Re-fit the tray into the shaped firebrick, and secure the front legs of the tray to the support.

Using 8mm diameter pipe, connect the appliance to the gas supply point. The appliance must be fitted with rigid or semi-rigid pipe of 8mm external diameter. The appliance is factory fitted with an inlet restrictor elbow.

Use a minimum length of 8mm pipe, less than 1.2m where possible, as a long run of pipe may cause an unacceptable drop in the supply pressure.

If using an across hearth connection, ensure the decorative firefront will clear the supply route. The rear of the firefront legs are notched to accommodate this.

8.0 FUEL BED LAYOUT

Coal Effect Option

1. Remove the combustion matrix from its protective packaging, and position onto the burner tray as shown. The front edge of the matrix should sit snugly behind the back edge of the burner rails. Do not fit the matrix on top of the burner rails.

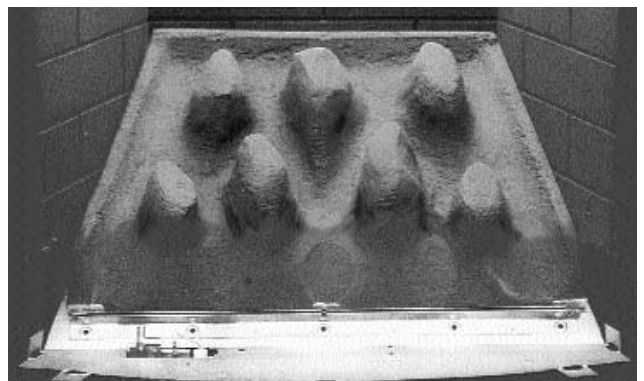

8.0

FUEL BED LAYOUT Coal Effect Option (continued)

2. Next, remove the front coal strip from its protective packaging and position as shown. The rear edge of the front coal strip should fit in front of the burner rail. Again, do not place on top of the burner rails. When the front coal is in position bend up the three metal tags at the front of the tray to retain (inset).

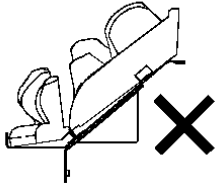
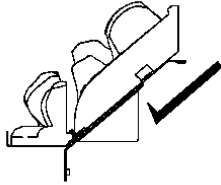

When the front coal is in position bend up the three metal tags at the front of the tray to retain (inset).

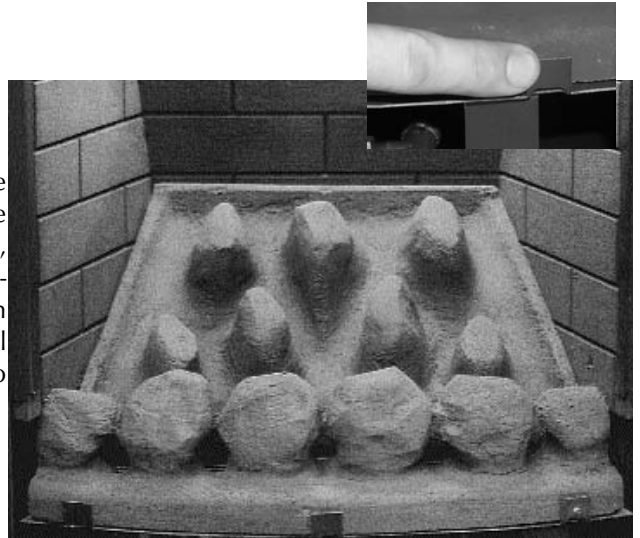

3. Open the bag of 16 moulded coals. All of the coals are the same. Take five coals and place them as shown. Care should be taken to ensure that the coals bridge the gap between the front coal and the four coal supports at the front of the matrix. Care should also be taken not to push the coals right down between the coal supports, as this can detract from the flame picture when the appliance is running.



4. Take five more moulded coals and position as shown to form the 'second row' of the fuel effect. The coals may be rotated as desired to fit into the gaps between the coal supports in order to create a random, realistic effect. Again, remember not to push the coals down too far into the valleys between the coal supports as this can have a detrimental effect to the flame picture.



5. Now take another four coals and place behind the second row of coals, in order to complete the third row. The coals may be orientated as desired to achieve a realistic effect. Keep the spacing between the coals even and uniform. The two coals at the ends of the row may be placed rearwards, towards the back corners of the fuel matrix.



8.0

FUEL BED LAYOUT Coal Effect Option (continued)

6. Finally, take the two remaining coals and place at the back of the fuel matrix, in the centre as shown. Adding these coals should complete the appearance of the fuel bed giving an even distribution of equally spaced coals.

→
The fire is designed to operate correctly with the coals supplied when assembled according to the instructions. Never add to the sixteen coals, or change them for a different type. Never throw rubbish or other matter onto the coal bed.



8.1

FUEL BED LAYOUT Pebble Effect Option

1. Refer back to section 12.0 - Fuel bed layout (coal effect option) and follow steps 1 and 2. The front strip and fuel effect matrix used for pebble effect versions are of the same design as coal effect versions, but have a different surface finish.

→
2. Open the bag of 16 ceramic pebbles. All of these pebbles are the same. Take five pebbles and place them as shown. Care should be taken to ensure that the pebbles bridge the gap between the front strip and the four supports at the front of the matrix. Care should also be taken not to push the pebbles right down between the supports, as this can affect the flame picture when the appliance is running.

→
3. Take five more ceramic pebbles and position as shown to form the 'second row' of the fuel effect. The pebbles may be rotated as desired to fit into the gaps between the supports in order to create a random, realistic effect. Again, remember not to push the pebbles down too far into the valleys between the supports as this can have a detrimental effect to the flame picture.

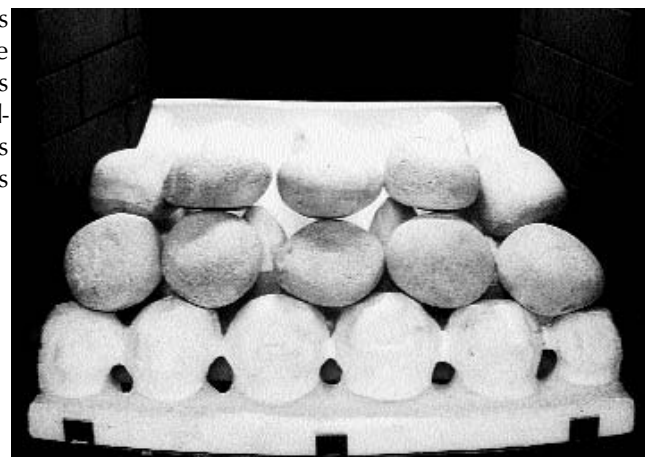
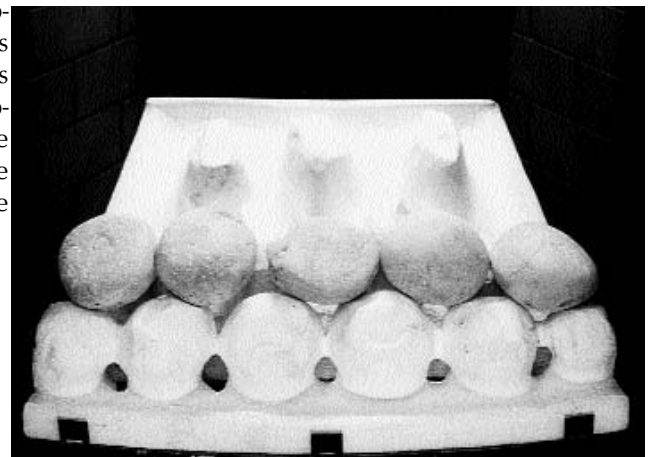
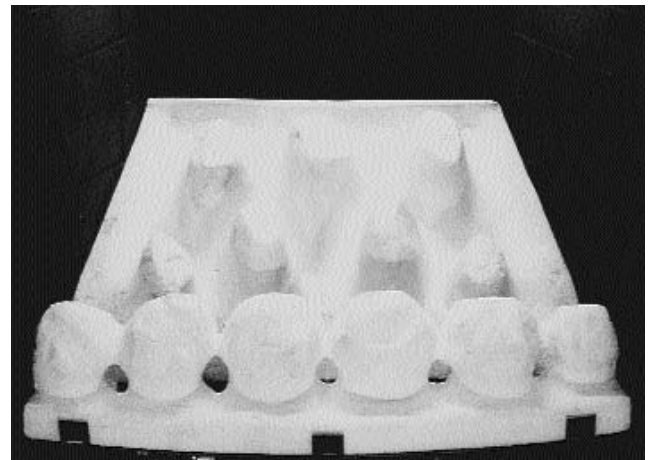

8.1

FUEL BED LAYOUT

Pebble Effect Option (continued)

4. Now take another two pebbles and place behind the second row of coals, next to each other in the centre of the fuel bed. The pebbles may be orientated as desired to achieve a realistic effect. Keep the spacing between the pebbles even and uniform.



5. Finally, take the four remaining large pebbles and place at the back of the fuel matrix as shown. Once again, the pebbles may be orientated as desired in order to give a realistic effect. Avoid pushing the pebbles down between the supports. The fuel bed layout is now complete.

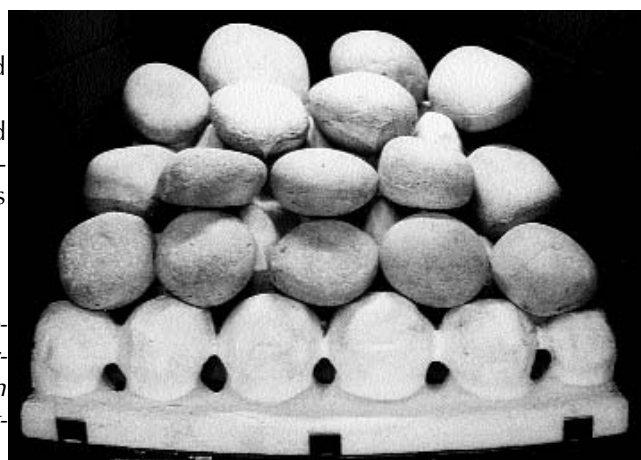

The fire is designed to operate correctly with the pebbles supplied when assembled according to the instructions. Never add to the sixteen pebbles, or change them for a different type. Never throw rubbish or other matter onto the coal bed.

Due to the light colour of the pebbles, some discolouration/sooting is to be expected during normal use.



8.2

FUEL BED LAYOUT

Log Effect Option

1. Refer back to section 12.0 - Fuel bed layout (coal effect option) and follow steps 1 and 2. The fuel effect matrix used for log effect versions is the same design as coal effect versions, but has a different surface finish. The front log strip is of a different design and must be handled with care.



2. Open the bag of 9 moulded ceramic logs. All of the logs except two are the same. Take the largest log (numbered 16) and place it as shown. Care should be taken to ensure that the orientation is correct and the log fits snugly into its position.



8.2 FUEL BED LAYOUT Log Effect Option Continued

3. Take the two medium sized logs (numbered 15 and 8) position the log numbered 8 on the left hand side ensuring correct orientation. Place the log numbered 15 on the right hand side again ensuring correct orientation. Both these logs will fit securely into their allocated position, they may require rotating slightly to ensure this.



4. Now take the remaining large log (numbered 4) and position vertically as shown, ensuring correct orientation. The base of this log must rest securely on the front log strip. Take one of the smaller logs (numbered 14) and position in between the two vertically positioned logs ensuring the orientation is correct. Keep the spacing between these logs uniform.



5. Finally, take the remaining two medium sized logs (numbered 5 and 7) and place in a horizontal position shown, 5 first, resting on the front log strip. 7 next resting on 5. Now take the smallest log (numbered 12) and position in the orientation shown ensuring the log does not fall into the matrix but rests securely on the allocated supports. Now take the final log (numbered 14) and place in a horizontal position as shown. Ensure there is even spacing between the logs and rotate if necessary to provide a stable fit onto the matrix. The fuel bed layout is now complete.



The fire is designed to operate correctly with the logs supplied when assembled according to the instructions. Never add to the nine logs, or change them for a different type. Never throw rubbish or other matter onto the fuel bed.

9.0 FITTING THE DECORATIVE FRONT

Unwrap the firefront and ashpan door. If the finials are not already fitted, screw them into the holes on the firefront and tighten.

Place the firefront directly in front of the fire and slide the ashpan door into place.

Do not use any firefront other than the one supplied with the appliance. The firefront shown in these instructions may differ from the one supplied with the appliance.

10.0 TESTING AND COMMISSIONING

Turn on and test the gas supply up to the fire for any leaks, in accordance with current Approved Codes Of Practice (ACOPs).

10.1 OPERATING THE FIRE (manual versions)

The pilot is visible through the left hand side of the front coal strip. Push in and turn the control knob to the SPARK position, and hold there for a few seconds.

Continue turning anti-clockwise through the spark click to the PILOT light position, ensuring the pilot has lit. If not, return the knob clockwise, and repeat.

When the pilot lights after the spark, keep the knob depressed for approximately ten seconds. Now release the knob and the pilot should stay alight. If not, retry ignition. If the pilot is extinguished during use, wait three minutes before repeating the ignition procedure.

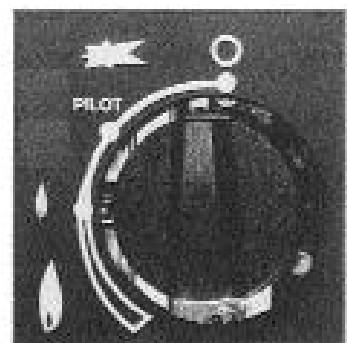

To achieve the HIGH setting, push the control knob in slightly and continue turning anti-clockwise to the high (large flame) position. The main burner should light after a few seconds.

To decrease the setting to LOW, turn the control knob clockwise to the low setting.

To turn to the PILOT position from the HIGH or LOW positions, press the control knob in, and return to the pilot position and release.

To turn the fire OFF, keep the knob pressed in, return to the off position and release.

A safety interlock prevents re-ignition of the pilot flame until the thermocouple has cooled sufficiently to allow the magnetic valve unit to reset itself.

10.2 OPERATING THE FIRE (remote control versions)

The gas valve has two control knobs ;

Turn the main burner control (shown on left hand side of control valve) knob fully anti-clockwise.

Turn ignition knob (shown on right hand side of control valve) slightly left towards the ignition position until reaching the stop, press down and hold for a few seconds until pilot gas is flowing.

Continue pressing down the knob while turning further to the left to activate the piezo spark, continue to hold the knob down for a further 10 seconds after the pilot has been lit. If the pilot does not light repeat the previous steps.

Upon lighting the pilot and after the further 10 seconds, release the knob and turn further to the left to the ON position. The main burner will light and be controlled in accordance with the main burner control knob setting. Adjust the main burner control knob to the desired setting.

If the pilot is extinguished during use of the fire, you must wait three minutes before repeating the ignition procedure.

To turn the main burner OFF whilst keeping the pilot flame lit, turn the ignition control knob to the pilot position then only the pilot will remain lit.



To shut the fire off completely, press the ignition control knob down and continue turning to the right from the pilot position to the OFF position.

A safety interlock prevents re-ignition of the pilot flame until the thermocouple has cooled sufficiently to allow the magnetic valve unit to reset itself.

The remote control unit allows operation of the main burner between maximum and pilot only setting. It does not turn the pilot on or off.

The remote control handset incorporates an inbuilt safety feature to prevent the main burner being activated or turned up accidentally. It is necessary to press button 1 and 2 (see illustration) simultaneously to turn the fire up.

To turn the fire down press button 3 only.

10.3 INSTALLING THE BATTERIES (Remote control versions only)

Handset - Remove cover from rear of handset and insert 1 x 'PP3' (9 volt) battery - Replace cover

Appliance - **Ensure appliance is off and cool.** Remove cover from top of receiver box. The cover is protected by reflective foil, and located towards the right hand side, underneath the burner unit. Insert 4 x 'AA' (1.5 volt) batteries - Replace cover.

10.4 SPARK FAILURE

The gap between the spark electrode and the pilot should be 3.5 - 4.5mm to produce a good spark. There should be no need to adjust this. If under any circumstances the electric spark fails, the pilot may be lit manually by proceeding with the ignition sequence as previously described, and after turning the control knob through the spark position, the knob should be held in and the pilot lit with a taper.

10.5 SETTING PRESSURE

Remove the screw from the pressure test point.

Manual control versions - The pressure test point is situated on the main injector pipe next to the pilot.

Remote control versions - The pressure test point is located directly above the gas control.

Attach a U gauge. Light the fire on the HIGH setting.

The setting pressure should be in accordance with the figures stated on page 2 of these instructions. The fire is factory set to achieve these pressures, and any significant variation could indicate a supply problem.

If the pressure is too high, the gas supply meter may be set incorrectly. This should be checked with the fire running and if necessary reset by the gas supplier.

If the pressure is too low, then check the meter governor pressure with the appliance running. If this is incorrect it will need to be reset by the gas supplier. If the setting pressure is too low, but the meter pressure is acceptable, then a problem in the supply pipework is to be suspected. This will be dirt and debris, kinked or inadequate size pipes, restriction in a fitting or solder flashing across a joint. (NOTE: you will not get an accurate reading of the inlet pressure with a pressure gauge on the end of the supply pipe - this is the static pressure in the system. You must use a T piece and measure the supply pressure with the fire on High - the dynamic pressure). Refit and tighten the screw into the pressure test point when the test is complete.

10.6 FLUE SPILLAGE MONITORING SYSTEM

This fire is fitted with a flue spillage safety device (ODS). If the fire shuts down during use for no apparent reason then several things may be suspected. If a door or window has been opened creating a draught, then pilot disturbance is the problem, and removal of the draught should resolve this. If a grommet seal has been left out of the firebox then this also will also cause intermittent shutdown. The gas pressure reaching the fire must also be checked. The thermocouple connection into the back of the gas control valve may also have worked loose during installation, simply tighten to remedy if this is the case.

If pilot disturbance is not the cause, then the ODS safety system may be in operation. Switch the appliance OFF, check the flue and carry out any remedial work required. Relight the fire and carry out a spillage test. **DO NOT** allow the appliance to be used if it continues to fail a spillage test.

The aeration hole of the pilot must be carefully cleaned out on each annual service to ensure continued function of the ODS.

The spillage monitoring system shall not be adjusted, modified, or put out of operation by the installer. Any spare parts fitted **MUST** be of a type supplied for the purpose by the appliance manufacturer.

If the fire is not spilling, then further guidance should be sought, using the Troubleshooting section as a guide.

10.7 TESTING FOR SPILLAGE

Close all doors and windows to the room containing the appliance. Let the fire run on HIGH for five minutes. Take a smoke match, light it, and using a smoke match tube, hold it at the top edge of the fire opening, 25mm down and 25mm in. Starting 50mm in from either side, run the smoke match across the opening. All the smoke should be drawn away up the flue. Any smoke returning into the room indicates that spillage is occurring. If the initial spillage test fails, run the fire for a further 10 minutes and repeat the test. When the test has been completed satisfactorily, repeat with any extractor fans in the premises running on the highest setting, and any communicating doors open. Finally, repeat with all doors open.

NOTE: *If spillage is still indicated after undertaking all of the above, there may be a fault in the flue, or insufficient ventilation is present.*

If the problem cannot be rectified immediately, then expert advice should be sought. Inform the user, disconnect the fire, and attach an explanatory label.

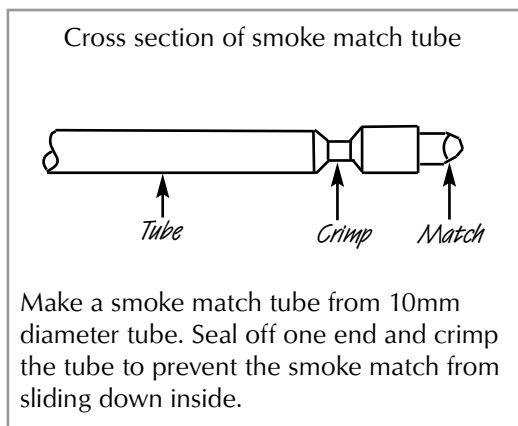

A. 25mm down from top of opening
B. 25mm in from front of opening.
C. Disregard outer 50mm either side of fireplace opening

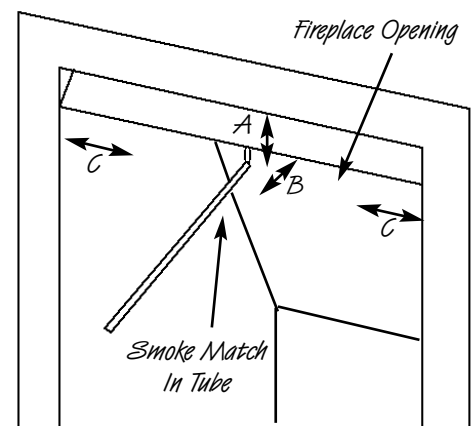

10.8 BRIEFING THE CUSTOMER

All instructions must be handed to the user for safekeeping. **Show the customer how to light and control the fire.**

After commissioning the appliance, the customer should be instructed on the safe use of the appliance and the need for regular servicing. Frequency of service depends on usage, but MUST be carried out at least one annually.

Scratched and other superficial damage to the matt black paintwork of the appliance can be covered with matching heatproof spray. Use only the manufacturers' recommended spray paint. Paint only when the fire is OFF and cold. Always mask off the surrounding area to prevent contamination with overspray. Ventilate the room during the use of the spray.

DO NOT attempt to spray paint the coals or ceramics, or wash them in water.

11.0 SERVICING

Ensure that the fire is fully cold before attempting service. A suggested procedure for servicing is detailed below.

1. Lay out the dust sheet and tools.
2. Carefully remove the firefront casting, and ceramic components.
3. Remove the decorative frame, and check frame top for discolouration and signs of spillage.
4. Isolate the gas supply at the appliance inlet elbow, and disconnect the gas supply pipe. Remove the two screws securing the tray to the firebox.
5. Lift the burner tray from the firebox.
6. Remove the firebox as detailed in the relevant section.

11.0 SERVICING (continued)

7. Check the area behind the firebox for rubble accumulation and remove. If debris is excessive, initiate remedial work on the flue.
8. Check the flue with smoke pellet for correct operation.
9. Re-fit the firebox using new seals where necessary.
10. Strip off the burner pipes and clean thoroughly.
11. Clean out the injector and pilot assembly. DO NOT attempt to dismantle the pilot unit.
12. Ensure the injector is aligned squarely with the venturi tube. Re-assemble and re-fit the burner tray.
13. Re fit and replace the ceramics, using genuine spares where necessary.
14. Re-fit the decorative front.
15. Turn on the gas supply, and leak test.
16. Check any purpose provided ventilation is un-obstructed.
17. Light the fire and test for spillage.
18. Check setting pressure and safe operation of the appliance.

For specific servicing instructions, see the relevant sections.

11.1 CLEANING THE COALS

Remove the firefront casting and place to one side. Remove the ceramic components. Gently clean in the open air. Be careful not to create dust from the coals. Where necessary replace damaged components with genuine spares. Seal scrap components in plastic bags and dispose of at proper refuse sites as directed.

Re-fit the coals carefully by referring to the relevant section of these instructions.

11.2 DISMANTLING THE BURNER TRAY

Remove the tray as previously described. The pilot unit can be removed by undoing the tubing nut, the thermocouple nut on the rear of the valve, lint arrestor, two securing screws, and lifting away. Remove the tubing nut from the valve end of the pilot pipe, and blow through to dislodge any debris that may be present. Clean the exterior of the pilot assembly with a soft brush and blow through the flame ports on the pilot head. Check the aeration holes are free from lint or dirt. The pilot assembly is a non-serviceable item, and should not be taken apart. The aeration hole must be absolutely clear internally for proper operation. A thoroughly cleaned (inside and out) oxypilot will cure a wide range of ignition faults.

Remove the two tubing nuts on the ends of the gas pipe to the injector elbow. Release the screw through the supporting leg and lift assembly clear. The injector pipe can now be checked for debris. Remove the nut retaining the injector elbow. Blow through the elbow to remove any debris.

Remote Control Versions - The valve is not field serviceable.

Manual Control Versions - The valve is not field serviceable, apart from the pilot filter. Remove the control knob by pulling it forwards, then remove the largest of the three screws on the face of the valve. Slide the filter out and clean away any debris that may have accumulated. The filter element should also be blown clean. This component should not require replacement, however if signs of deterioration are evident then a genuine spare must be used. If a large amount of debris is present in the filter then the pipework and control should be thoroughly cleaned before re-assembly.

12.0 TROUBLESHOOTING GUIDE

Fire sparks but pilot does not light

No gas to fire, check isolators are open.
Pipework blockage, clean out.
Air not fully purged, repurge supply or wait longer.
Spark earthing to metal work, reset gap correctly.
Blocked pilot, clean out internally.

Pilot lights but then goes out

Severe restriction in gas supply, clear obstruction.
Faulty thermocouple, replace pilot unit.
Hold control knob in for longer.
Manual versions only - Check control knob does not foul data plate.

Fire does not spark at pilot

HT lead detached, refit.
Spark gap too large or small, reset correctly.
Faulty piezo unit, replace.
Debris shorting out electrode, clean.

Fire runs for a time and then cuts off

Excessive room draught or flue pull, rectify.
Loose or faulty thermocouple, rectify.
ODS system in operation.
Firebox grommet seal not fitted, rectify.
Lint in pilot aeration hole, clean thoroughly internally

Pilot flame shrinks when fire is on high

Poor gas flow to fire, check pressure with fire on high.
If pressure is low, remove any restriction in pipework or valve.
Check all isolators are adequately sized and fully open.
Check meter pressure is adequate.
Air leak under base of firebox, rectify.
Lint in pilot aeration hole, clean thoroughly internally.

Fire smells when first lit or in use

Newness smell from brand new appliance.
Spillage occurring. Carry out spillage test and rectify any problems.
Low temperature sealants or combustible materials used in incorrect positions.

USER INSTRUCTIONS

<i>Section</i>	<i>Contents</i>	<i>Page No.</i>
1.0	Important Notes	1
2.0	Firefront	2
3.0	Clearances to Combustibles	2
4.0	Ventilation	2
5.0	Operating Instructions	2
6.0	Replacing the batteries (remote control versions only)	3
7.0	Flue Spillage Monitoring System	3
8.0	Cleaning	3
9.0	List of Spares	4

1.0 IMPORTANT NOTES

The installation of this fire MUST only be carried out by a competent person (such as a CORGI registered fitter) in accordance with the Gas Safety (Installation and Use) Regulations 1998, the relevant British Standards, Codes of Practice, the Building Regulations and the manufacturers' instructions.

Failure to comply with the above recommendations could lead to prosecution and invalidate the appliance warranty.

Please ensure you are handed all of the manufacturers documents on completion of the installation. This will include these instructions.

Always keep a note of the installer's name and address, the original purchase receipt and the date of installation for future reference.

The fire and flue should be serviced regularly to ensure continued safe operation. See the servicing section for further details. Frequency of service will depend on use, but MUST be carried out at least once annually.

Parts of this appliance become naturally hot during use. It is recommended that a suitable fire guard conforming to BS 6778 is used, especially where young children, the elderly, or infirm are concerned.

Combustible items, such as flooring and furniture, and soft wall coverings (such as blown vinyl or embossed paper) may discolour if fitted too close to the fire. See relevant section for further details on clearances to combustibles. No combustible material or flooring should protrude onto the hearth.

DO NOT burn any foreign material on this fire, the fuel effect must be of the correct type and laid out in accordance with the relevant section of these instructions. Failure to do so could create a hazard or lead to sooting.

Before the appliance is installed, the chimney should be swept. All flues should be checked by the installer to ensure there are no defects or obstructions that may prevent the flow of combustion products.

This appliance is fitted with a flue blockage safety device which will shut down the fire if abnormal flue conditions occur. It is NOT a substitute for an independently mounted Carbon Monoxide detector.

The fire is only suitable for use with the gas type for which it is supplied.

Remote control models only - This appliance features a battery-operated remote control system. Remote control models, under normal usage will need new batteries approximately every twelve months.

Remote control Handset requirements - 1 x 'PP3' type (9 volt)

Receiver/motor unit requirements - 4 x 'AA' type (1.5 volt)

Refer to the appropriate section of these instructions for details of how to change the batteries.

2.0 FIREFRONT

This fire is supplied with a particular style of firefront. Use of the firefront will ensure an adequate airflow under the firebed for the correct functioning of this appliance.

Compliance with safety standards cannot be guaranteed if another style of front is used.

3.0 CLEARANCES TO COMBUSTIBLES

A combustible shelf may be fixed to the wall above the fire, providing that it complies with the dimensions given below.

<i>Maximum depth of shelf</i>	<i>Minimum distance from inside edge of fire frame to underside of shelf</i>
100mm (4in)	745mm (29 1/4 in)
150mm (6in)	845mm (33 1/4 in)
203mm (8in)	895mm (35 1/4 in)

A non-combustible shelf may be fitted to within 10mm of the top edge of the fireframe.

Combustible materials, such as wood, may be fitted to within 100mm (4in) of either side of the frame of the appliance, providing the forward projection does not exceed 100mm (4in).

Any combustible side walls must be at least 500mm to the side of the radiant heat source.

As with all heating appliances, any decorations, soft furnishings, and wall coverings (i.e. flock, blown vinyl and embossed paper) positioned too close to the appliance may discolour or scorch.

4.0 VENTILATION

No purpose provided ventilation is normally required for this appliance. The requirements of other appliances operating in the same space or room, and the results of a spillage test must be taken into consideration when assessing ventilation requirements, this will have been carried out by your CORGI registered installer.

For Republic of Ireland, ventilation may be required, see IS 813, ICP3, IS 327, and any other rules in force.

5.0 OPERATING INSTRUCTIONS (manual versions)

The pilot is visible through the left hand side of the front coal strip. Push in and turn the control knob to the SPARK position, and hold there for a few seconds.

Continue turning anti-clockwise through the spark click to the PILOT light position, ensuring the pilot has lit. If not, return the knob clockwise, and repeat.

When the pilot lights after the spark, keep the knob depressed for approximately ten seconds. Now release the knob and the pilot should stay alight. If not, repeat ignition. If the pilot is extinguished **during use**, wait three minutes before repeating the ignition procedure.

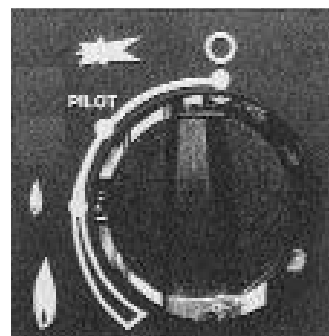

To achieve the HIGH setting, push the control knob in slightly and continue turning anti-clockwise to the high position. The main burner should light after a few seconds.

To decrease the setting to LOW, turn the control knob clockwise to the low setting.

To turn to the PILOT position from the HIGH or LOW positions, press the control knob in, and return to the pilot position and release.

To turn the fire OFF, keep the knob pressed in, return to the off position and release.

5.1 OPERATING INSTRUCTIONS (remote control versions)

The gas valve has two control knobs ;
Turn the main burner control (shown on left hand side of control valve) knob fully anti-clockwise.
Turn ignition knob (shown on right hand side of control valve) slightly left towards the ignition position until reaching the stop, press down and hold for a few seconds until pilot gas is flowing.
Continue pressing down the knob while turning further to the left to activate the piezo spark, continue to hold the knob down for a further 10 seconds after the pilot has been lit. If the pilot does not light repeat the previous steps.
Upon lighting the pilot and after the further 10 seconds, release the knob and turn further to the left to the ON position. The main burner will light and be controlled in accordance with the main burner control knob setting. Adjust the main burner control knob to the desired setting.

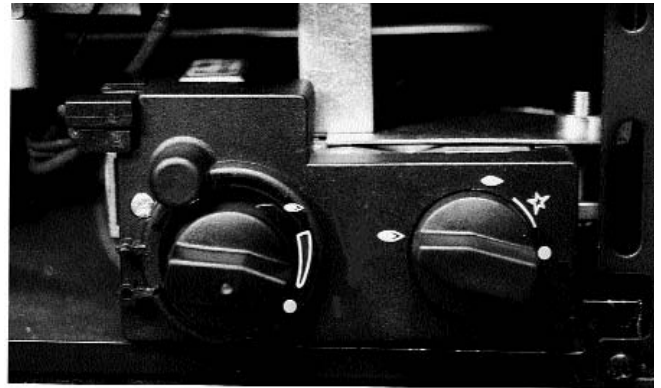

If the pilot is extinguished during use of the fire, you must wait three minutes before repeating the ignition procedure.
To turn the main burner OFF whilst keeping the pilot flame lit, turn the ignition control knob to the pilot position then only the pilot will remain lit.
To shut the fire off completely, press the ignition control knob down and continue turning to the right from the pilot position to the OFF position.
A safety interlock prevents re-ignition of the pilot flame until the thermocouple has cooled sufficiently to allow the magnetic valve unit to reset itself.

The remote control unit allows operation of the main burner between maximum and pilot only setting. It does not turn the pilot on or off.
The remote control handset incorporates an inbuilt safety feature to prevent the main burner being activated or turned up accidentally. It is necessary to press button 1 and 2 (see illustration) simultaneously to turn the fire up.
To turn the fire down press button 3 only.

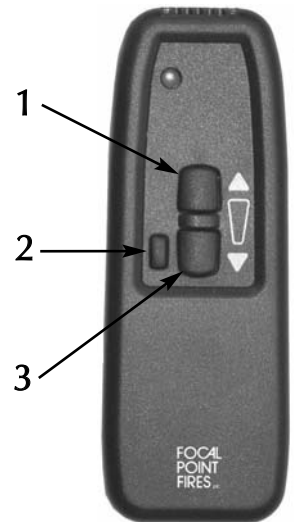

6.0 REPLACING THE BATTERIES (remote control versions only)

Handset - Remove cover from rear of handset and insert 1 x 'PP3' (9 volt) battery - Replace cover
Appliance - **Ensure appliance is off and cool.** Remove cover from top of receiver box. The cover is protected by reflective foil, and located towards the right hand side, underneath the burner unit. Insert 4 x 'AA' (1.5 volt) batteries - Replace cover.

7.0 FLUE SPILLAGE MONITORING SYSTEM

This fire is fitted with a flue spillage safety device (ODS). If the fire shuts down during use for no apparent reason then several reasons may be suspected. If a door or window has been opened creating a draught, then pilot disturbance could be the problem, and removal of the draught should resolve this. The fire can then be re-lit in accordance with the previous section. A sealing grommet may have been omitted when the fire was installed, and the original installer should be called to check this, the gas pressure and pipework.

If pilot disturbance is not the cause, then the ODS safety system may be in operation. Switch the appliance OFF, call in your installer to check the flue and ventilation and carry out any remedial work required. **DO NOT** allow the appliance to be used until the flue system is passed as safe.

8.0 CLEANING

Before carrying out any of the following operations, ensure that the fire is OFF and completely cold. Debris that may form on the firebed should be periodically removed by a competent person. Large deposits could indicate deterioration of the flue. This should be repaired by a competent person, and the fire serviced before further use.

8.0 CLEANING (continued)

FIREFRONT - Any dust accumulating in the firefront may be removed using a vacuum cleaner or dry cloth. Heavy stains may be removed by using a damp cloth and mild household detergent. Brass parts of the firefront may be cleaned using a suitable brass cleaner. Replace the front centrally against the fire after cleaning.

PAINTED AREAS - These can be cleaned using a dry cloth.

COALS AND CERAMICS - See the relevant section in the Installation Guide of these instructions. Do not create dust from the coals. Clean gently in the open air. Replace components with original spares only as necessary.

9.0 LIST OF SPARES

<i>PART NO.</i>	<i>ITEM</i>
F550038	Pack of 16 coals
F550050	Pack of 16 large ceramic pebbles
F550051	Pack of 2 small ceramic pebbles
F780007	Fuel Matrix (coal version)
F780012	Fuel Matrix (pebble version)
F780008	Front ceramic strip (coal version)
F780013	Front ceramic strip (pebble version)
F730006	Pilot unit
F930017	Remote control (handset only)
Please Enquire	Decorative Frame
Please Enquire	Decorative Front