

**FOCAL
POINT
FIRES** plc

Mayon

FLUELESS INSET GAS FIRE

**INSTALLATION, SERVICING
AND USER INSTRUCTIONS**

All instructions must be handed to the user for safekeeping

Revision A - 06/03

Country(s) of destination - GB,IE

This appliance is for use with Natural Gas (G20) ONLY

Focal Point Fires plc, Avon Trading Park, Christchurch, Dorset BH23 2BT

Tel: 01202 499330 Fax: 01202 499326

www.focalpointfires.co.uk

e-mail: sales@focalpointfires.co.uk



INSTALLATION INSTRUCTIONS

Preliminary Notes Before Installation

This is a High Efficiency, Flueless, Inset Live Fuel Effect appliance. It provides radiant and convected warmth both efficiently and safely utilising the latest type catalytic converter burner technology.

This fire incorporates a combustion monitoring system (Oxygen Depletion Sensor). It must not be adjusted or put out of operation. If replaced then manufacturers original parts must be used. The fire is designed to fit various types of situations as listed in the Installation Requirements.

This appliance must be installed in accordance with the rules in force and only used in a sufficiently ventilated space. *A minimum of 100cm² (15.5 in²)* purpose provided ventilation is required for this appliance, an openable window or louvre is also required. This appliance is factory set for operation on the gas type, and at the pressure stated on the appliance data plate.

The room size should be a minimum of 30m³ (1059ft³) to allow adequate circulation of air and ensure the correct operation of the fire when installed in a living room. This volume may include adjacent spaces but these spaces must not be separated by a door. In order to convert from cubic feet (ft³) to cubic metres (m³) divide the room volume (in ft³) by 35.3. This appliance is intended as a secondary source of heat only, and should not be used in a room without some form of background heating present.

The appliance must not be installed in a bedroom, bathroom or any sleeping area. The appliance does not require a flue system of any type as the catalytic converter cleans the combustion products to provide a complete combustion system which is intrinsically safe.

The appliance must be installed by a competent person in accordance with Gas Safety (Installation and Use) Regulations 1998 or rules in force. It is strongly recommended that a CORGI registered engineer is used for this purpose as they are the only persons approved by the HSE under the above regulations.

On initial lightup of a new appliance, the 'newness' smell will burn off within the first few hours of operation. During this period some smoke may be emitted from outlet louvres, this should be no cause for concern. Accordingly, the room should be well ventilated during this period.

Read all these instructions before commencing installation.

Section	Contents	Page No.	Section	Contents	Page No.
1.0	Important Notes	1	8.1	Cable Fixing	9
2.0	Appliance Data	2	9.0	Fuel Bed	9
3.0	Installation Requirements	2	10.0	Fitting Decorative Hood/Frame	10
3.1	Room Sizing	2	11.0	Testing and Commissioning	10
4.0	Site Requirements	2	11.1	Operating the Appliance	10
4.1	Ventilation	3	11.2	Spark Failure	11
5.0	Unpacking the Appliance	4	11.3	Setting Pressure	11
5.1	Component Checklist	4	12.0	Briefing the Customer	11
6.0	Appliance Installation	4	13.0	Servicing	11
6.1	Preparing the Appliance	4	13.1	Cleaning the Coals	12
6.2	Gas Supply Routes	5	13.2	Servicing the Burner Tray	12
6.3	Installation Method 1	5	13.3	Pilot Assembly	12
6.4	Installation Method 2	6	13.4	Catalytic Converter	12
6.5	Installation Method 3	7	13.5	Testing for Firebox Leakage	13
7.0	Gas Supply	8	14.0	Troubleshooting Guide	14
8.0	Final Cavity Box Fixing	8		User Instructions	

1.0 IMPORTANT NOTES

This fire is an Inset Live Fuel Gas Fire, providing radiant and convected warmth. It is designed to operate on Natural Gas following factory set adjustments, (see Data Plate on appliance for gas type and pressure).

It is the LAW that all gas appliances and fittings are installed by a competent person (such as a CORGI registered fitter) and in accordance with the Gas Safety (Installation and Use) Regulations 1998, the relevant British Standards for Installation, Codes of Practice and the Manufacturers' Instructions. The installation shall also be carried out in accordance with the following regulations:

The Building Regulations issued by the Department of the Environment, the Building Standards (Scotland) (Consolidation) Regulations issued by the Scottish Development Department.

Relevant British standards insofar as the relevant areas are not covered by these instructions.

Note: For Republic of Ireland, reference should be made to the relevant standards governing installation. (IS 813: 1996)

Failure to comply with these regulations could lead to prosecution and deem the warranty invalid.

This appliance must be installed in accordance with the rules in force and used only in a sufficiently ventilated space. A minimum of 100cm² (15.5 in²) purpose provided ventilation is required for this appliance, an openable window or louvre is also required. To reduce the possibility of draughts entering the room via the air vent, we recommend the use of "Black Hole" or "Vortex" type vents featuring internal baffles.

Consult ALL instructions before installation and use of this appliance.

This appliance is free from any asbestos material. Refractories and coal bed are constructed from ceramic fibre.

2.0

APPLIANCE DATA

Gas Group		G20 Natural Gas CAT 12H
Inlet Pressure		20 mbar
Max Energy Input		Gross 2.6 kW Net 2.35 kW
Max Gas Rate		0.25 m ³ /h
Min Energy Input		Gross 1.5 kW Net 1.35 kW
Pilot Energy Input		Gross 166 W Net 150 W
Setting Pressure	High	7.0 mbar (+/-0.25 mbar). Cold 7.5 mbar (+/-0.25 mbar). Hot
	Low	2.0 mbar (+/-0.25 mbar). Cold 2.8 mbar (+/-0.25 mbar). Hot
Main Injector Burner		Stereo. Size 60 / Bray Cat 82 - 280
Gas Inlet Connection		8 mm compression
Ignition		Piezo spark
Spark Gap		4.0 mm (± 1.0mm)
Weight		20 Kg

Please see Data Badge affixed to appliance for current data.

This appliance is for use only with the gas type, and at the pressure stated on the appliance Data Badge.

3.0

INSTALLATION REQUIREMENTS

The fire has been designed to be installed in two main applications; either to fit into a suitable opening created in the inner leaf of an outside wall or false chimney breast/extended fire surround built to conceal the appliance. The appliance can also be fitted into an unserviceable or inoperative fireplace served by a disused natural draught flue. It is recommended that the old flue should be partially sealed off to prevent draughts, however some ventilation will be required in the old flue to prevent condensation and dampness.

The cavity box and firebox must be installed onto a suitable non-combustible insulating surface at least 12 mm thick covering the entire base area of the box. The fire must be used with a back panel capable of withstanding 150°C minimum. Any combustible materials directly behind the fire frame (or back panel) and close to the cavity box of the fire must be removed and replaced with non-combustible material such as cement, browning, 'Superlux' board or equivalent materials.

3.1

ROOM SIZING

The room size should be a minimum of 30m² (e.g. 11'6" x 11'6" x 8') to allow adequate circulation of air and ensure the correct operation of the fire. To calculate a room size in cubic metres (m³) divide the room volume in cubic feet (ft³) by 35.3.

4.0

SITE REQUIREMENTS

The appliance may be installed by one of the following methods:

1. Fitment against the inner face of a house wall with a suitably constructed false chimney breast or rebated fire surround to enclose the depth of the fire. If a timber false chimney breast is constructed, clearances and insulation must be as for a timber constructed wall.
2. Insertion into a purpose made opening in the inner leaf of a cavity wall or a disused conventional fireplace opening. Bridging the cavity may cause unwanted moisture to track to the inside of the house from the cavity and therefore should be avoided. Protection from moisture and falling debris above the cavity box should be provided. If in doubt consult local building control officers.
3. Installation into a timber framed house wall using clearances and insulation as described in the appropriate section. If in doubt, consult local building control officers.

The opening dimensions for inseting the appliance must be; **WIDTH** : between 410 mm and 440 mm and **HEIGHT** : between 560 mm and 580 mm high. The opening must be within these sizes for the full depth of the cavity box in non-combustible applications. Applications involving combustible materials e.g. timber battens in false chimney breasts, must use appropriate clearances and insulation methods as described in the relevant section of these instructions.

4.0 SITE REQUIREMENTS (continued)

Opening *DEPTH* must be 145 mm or greater. Opening *DEPTH* includes any plaster, cement or infill/back panels that form part of the installation.

In the event that the fire is sited in a disused or unserviceable fireplace served by a natural draught flue, any existing under grate draught device should be sealed off to prevent loss of heat or creation of draughts. The passageway into the flue should be partially sealed to prevent excessive draughts, however some ventilation will be required in the old flue to prevent condensation and dampness. Advice should be sought from your local building control officer.

If a concealed gas connection is to be made, the supply pipe should always be sleeved through walls and floors using the shortest possible route. It is possible to install the gas supply from the side of the hearth and round into the cavity but use only factory sleeved pipe. A length of no more than 1.5m of 8mm diameter pipe must be used to avoid unnecessary pressure drops.

The wall for the opening must be non-combustible or prepared as described in the relevant section. Bare plasterboard must be protected by non-combustible plaster or replaced with non-combustible material (e.g. Superlux board). Any gap between wall boards and the wall must be filled using glass fibre insulation, silicone mastic or similar material to prevent heat ingress.

If the appliance is to be installed as a 'hole in the wall' fire it does not require any hearth as such, providing it is mounted more than 150mm (6") above floor level. NOTE: Depending on the fret and trim type supplied with the fire, a suitable non-combustible ledge for placement of the fire front will be required.

The appliance requires a hearth with a non-combustible surface of at least 12 mm thick, projecting 100mm from the front of the appliance. The top surface must be at least 50 mm above the surrounding floor level or be surrounded by a raised edge or fender 50 mm high.

Any type of fire surround used with this appliance must be adequately sealed to the wall and floor to prevent excess draughts from around the back of the fire. The temperature rating of any surround used must be 150°C minimum.

A combustible shelf may be fixed to the wall above the fire, providing that it complies with the dimensions given below.

<i>Maximum depth of shelf</i>	<i>Minimum distance from hearth to underside of shelf</i>
180mm	850mm
100mm	790mm

The shelf depth may be greater but the height must also be increased accordingly. An increase in height of 25 mm is required for every 12.5 mm of additional shelf depth. For shelves that are too low protective devices can be used such as metal heat deflectors, but it must be assured that the shelf does not reach an unacceptable temperature before relying on such a solution. A non-combustible shelf may be fitted to within 100mm of the top edge of the fire frame, but any articles placed on it must also be tolerant of high temperatures.

Combustible materials such as wood may be fitted to within 100mm (4in) of either side of the fire frame / trim, providing the forward projection does not exceed 100mm (4in). Any combustible sidewalls must be at least 500mm to the side of the radiant heat source.

As with all heating appliances any decorations, soft furnishings and wall coverings (i.e. flock, blown vinyl and embossed paper) positioned too close to the appliance may discolour or scorch.

4.1 VENTILATION

A minimum of 100 cm² purpose provided ventilation is required for this appliance. An openable window or louver is also required. The requirements of other gas appliances operating in the same room or space must be taken into consideration when assessing ventilation.

Any ventilation fitted must comply with BS 5871 part 2 and BS 5440 part 2 insofar as the relevant areas are not covered by these instructions. Ventilation fitted under or within immediate vicinity of the appliance must not be used as it may adversely effect performance of the ODS system. The appliance **MUST NOT** be installed in a bedroom, bathroom or any sleeping area. For Republic of Ireland, see relevant rules in force.

5.0 UNPACKING THE APPLIANCE

Stand the carton the right way up, cut the strapping bands and remove the top endcap. Read ALL these instructions before continuing to unpack or install this appliance.

Remove the box containing the cast front fret, and the box containing the ceramic coals and other ceramic firebed components. Remove the cardboard packing pieces and any other bags or boxes containing fittings or other parts. When all loose parts have been removed, the outer sleeve may be lifted off to reveal the appliance. Check that the components supplied against the component checklist. Please dispose of all the packaging materials at your local recycling centre.

5.1 COMPONENT CHECKLIST

<i>QUANTITY</i>	<i>DESCRIPTION</i>
1	Cavity box, firebox and burner assembly fitted with glass panel
1	Decorative frame
1	Hood
1	Cast front fret with separate ashpan door
1	Moulded ceramic fibre combustion fuel bed
1	Ceramic pad set
1	Sealing grommet
1	Cable fixing kit
1	Screw and rawl plug pack
1	Set of manufacturers instructions and warranty card

6.0 APPLIANCE INSTALLATION

Note: Ensure that the gas supply is isolated before commencing installation of the appliance.

The fireplace opening and environment must be in compliance with specifications laid down in the appropriate sections of these instructions.

6.1 PREPARING THE APPLIANCE

Remove the appliance from its carton as described previously and stand on a dustsheet. Remove the glass panel and place it and the coals, ceramics and fixings safely to one side.

Lay the fire on its back. Remove the firebox assembly from the cavity box by removing the fixings provided on the front of the firebox frame. Place the firebox to one side for the time being.

Knock out holes are provided in the rear and sides of the cavity box for use where concealed pipework is required. Note: Knock out holes are also provided in the sides of the inner firebox if a side-entry pipe routing is required, but it is not necessary to seal these holes with grommets. Knock out the appropriate hole in the cavity box with a sharp tap from a hammer and fit the rubber grommet supplied. A small incision can now be made in the rubber to slip snugly around the outside of the supply pipe and sleeving.

Note: Do not install or use the appliance without this seal in place.

6.2 GAS SUPPLY ROUTES

The gas supply may enter the fire over the hearth or by concealed connection behind the fire.

Following preparation of the fixing method, the concealed gas supply (if required), can now be installed. When the opening is ready for installation the gas supply can be routed (examples are shown in the following diagram). If the gas pipe has been sleeved the ends of the sleeving must be sealed. The end

of the 8mm pipe should be temporarily sealed to prevent the ingress of debris during fixing. An isolator cock or restrictor elbow must be fitted to the incoming supply to facilitate servicing.

Concealed pipes should not be routed through walls without being protected by sleeving or conduit.

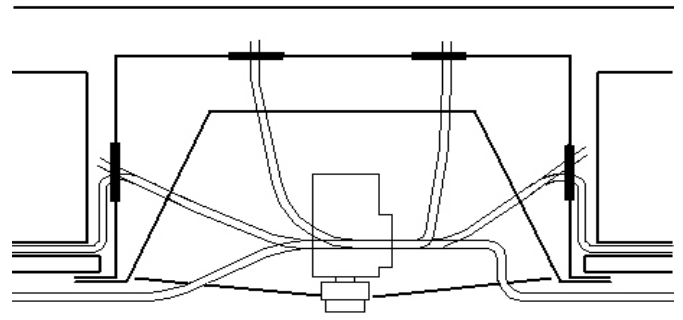

For Installation Method 1 (mounting against a wall) the supply can be routed in the normal manner. For Installation Method 2 (insetting into the inner leaf of a cavity wall) use only factory sleeved pipe in a continuous unjoined length in the cavity of the wall and areas that communicate with the cavity. This is a permitted gas supply pipe routing.

6.3 INSTALLATION METHOD 1 (against a non-combustible inside wall)

This method requires no modifications to the internal wall of a property and is achieved by using either a surround with extended rebate or a false chimney breast of minimum 145mm internal depth.

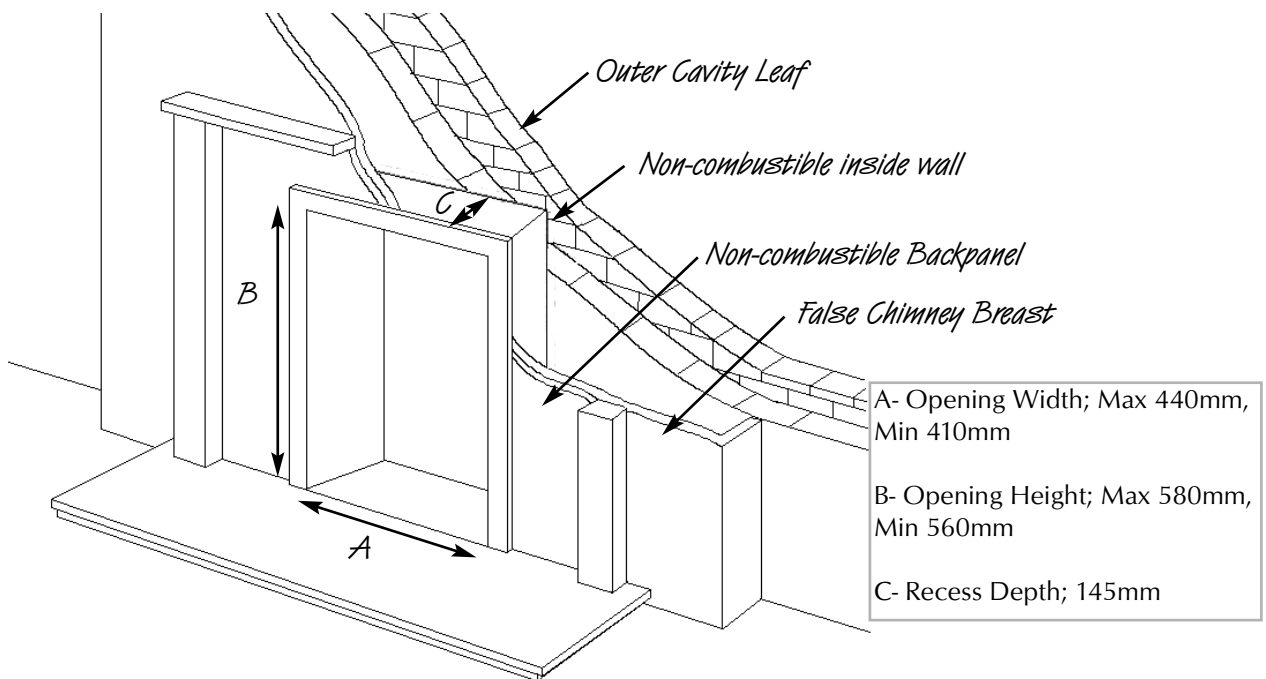

A false chimney breast should be installed, taking into account any guidance given in the section on timber framed buildings as far as insulation and clearances are concerned. As a general rule, when the false chimney breast is constructed from combustible materials the cavity box must be separated from any combustible materials by a minimum 75mm air gap at the sides and rear and 100mm air gap above the cavity box. Alternatively the cavity box may be insulated with 75mm of fibre glass wool or rock wool to the sides, rear and 100 mm to the top.

Finally install the fireplace or fire surround and back panel/marble to its finished location.

6.4 INSTALLATION METHOD 2 (recessing into a non-combustible wall)

This method allows for installation of the appliance with the rear part recessed into the inner leaf of a cavity wall. This should enable a standard fire surround and back panel/hearth set to be fitted to the wall with the fire presented naturally in a flush fitted manner. The structural integrity of the wall must be maintained.

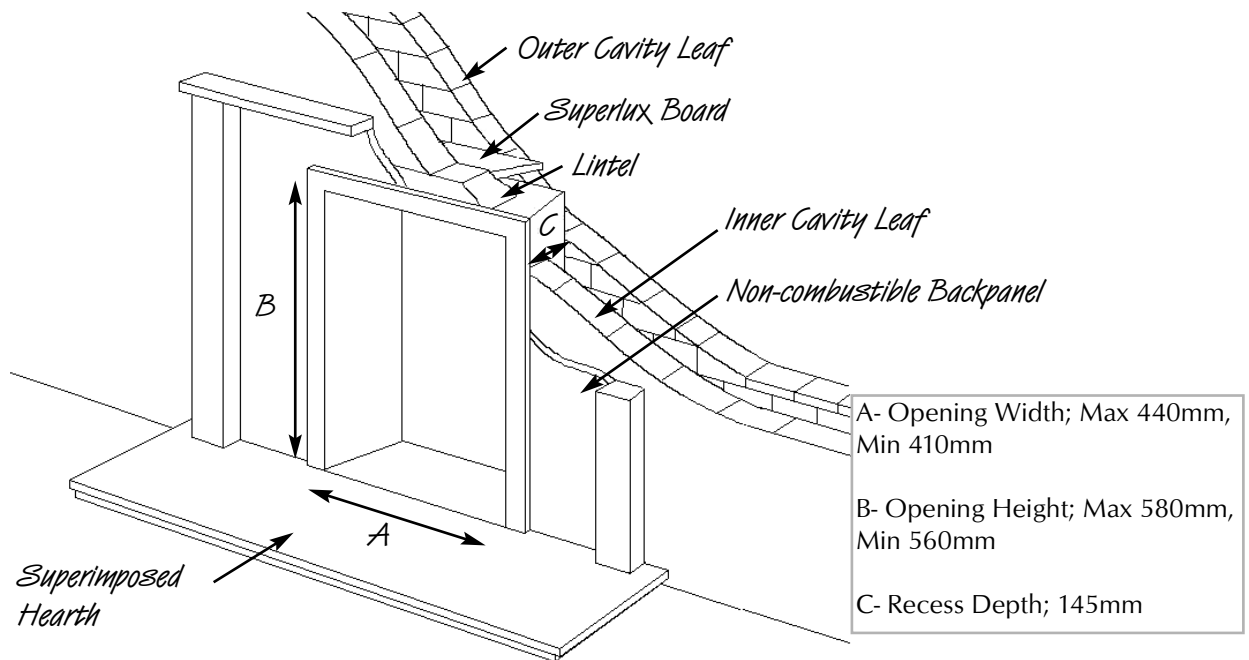

Check the cavity insulation type (if applicable). If cavity insulation is of a loose fill variety, take precautions to prevent excessive loss of material when the inner leaf is opened up by packing the cavity firmly with a minimum 50mm of rockwool or glass fibre. This will hold back any loose material now or in the future.

To maintain the structural integrity of the wall it is recommended that a suitable lintel is fitted. It is sometimes possible to install this appliance without a lintel, depending on the type of wall. The guidance of a qualified professional or local building control officer is essential to confirm this.

Mark out the area of the proposed fireplace opening on the wall. Obtain a suitable concrete or steel lintel from a builder's merchant. Drill four holes at the corners of the lintel position and squarely over the fireplace opening, and if possible centrally under a block joint. Clear out the block work in the area and insert the lintel by saw, or stitch drill and chisel. Do not dry bed the lintel - always bed on mortar and securely slate pin. Clear out the block work from below the lintel to form the opening for the cavity box of the fire to be inserted.

The top of the exposed area of cavity must be sealed against the ingress of moisture dripping from above. The best way to do this is a cavity tray but an easier and quicker method is to affix a 'Supalux' or equivalent board into the cavity. Slope the board towards the outside wall and support with screws, cement, 'Unibond' or silicone mastic etc. This will guide all moisture, harmlessly, to the outside wall. The exposed sides of the cavity must be packed with a suitable depth (minimum 50mm) of glass fibre or rock wool to prevent draughts and heat loss, even if no loose fill material is present. It is good practice to insulate the rear of the fire from the cavity to prevent heat loss and condensation.

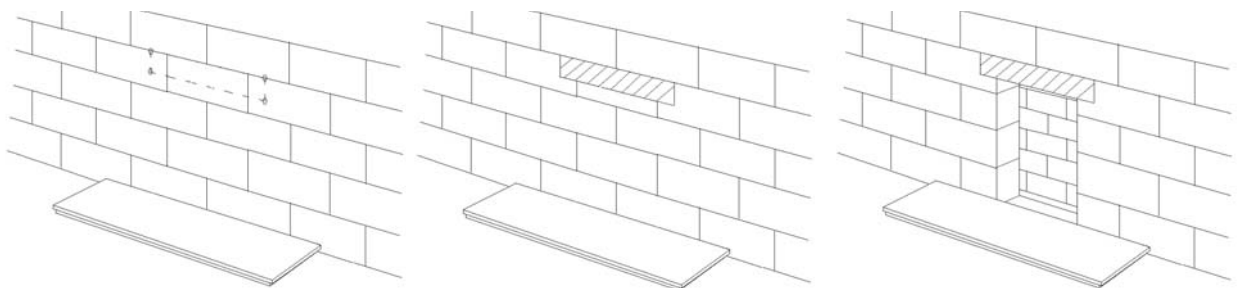

The non-combustible hearth may now be put in place. Again this should not bridge the cavity where it projects into the wall space. Finally install the fireplace or fire surround and back panel/marble to its finished location.

6.5 INSTALLATION METHOD 3 (timber framed buildings)

Where removal of any part of a timber frame is undertaken the structural integrity of the wall must be retained. The advice of your local building control officer should be sought. If the property is under any NHBC warranty it is also advised that their advice on this kind of modification is sought.

Either of the two preceding installation methods may be adapted for timber framed buildings, providing extra care is taken in ensuring combustible materials are adequately protected from the effects of heat.

The appliance must be installed in accordance with the British Gas documents DM2 and DM3 or the Institute of Gas Engineers published procedure document IGE/UP/7.

Special attention must be paid to the location of studwork frames of the inner leaf and the appliance positioned accordingly. Wires and pipes that run within the wall must also be taken into account.

Installation as per method 1 (against inner wall)

When using this method of installation the following amendments should be incorporated.

A 75mm air gap or 75mm of insulation (e.g. rockwool) must be provided between combustible materials and the sides and rear of the cavity box. A 100 mm air gap or 100mm of insulation (e.g. rockwool) must be provided to the top of the cavity box. It is also a good idea to enable as much airflow as possible, into and out of the area behind the fire without excessive heat loss from the room when the fire is off.

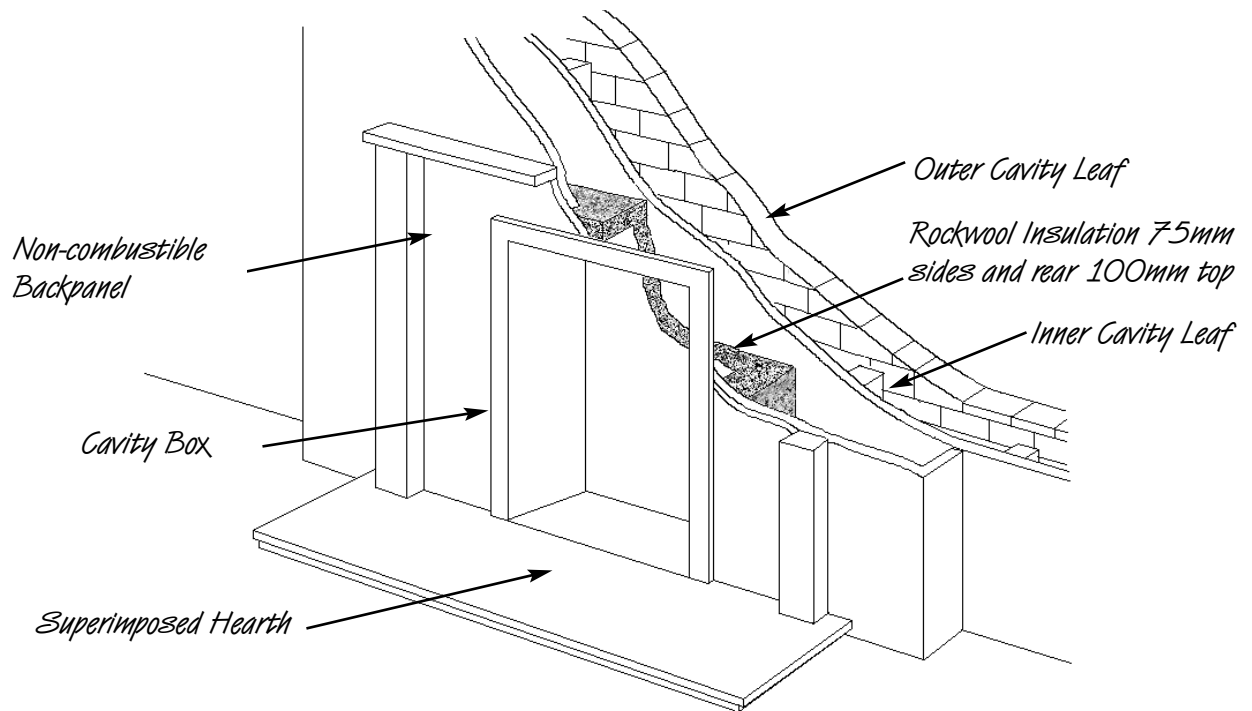

6.5 INSTALLATION METHOD 3 (continued)

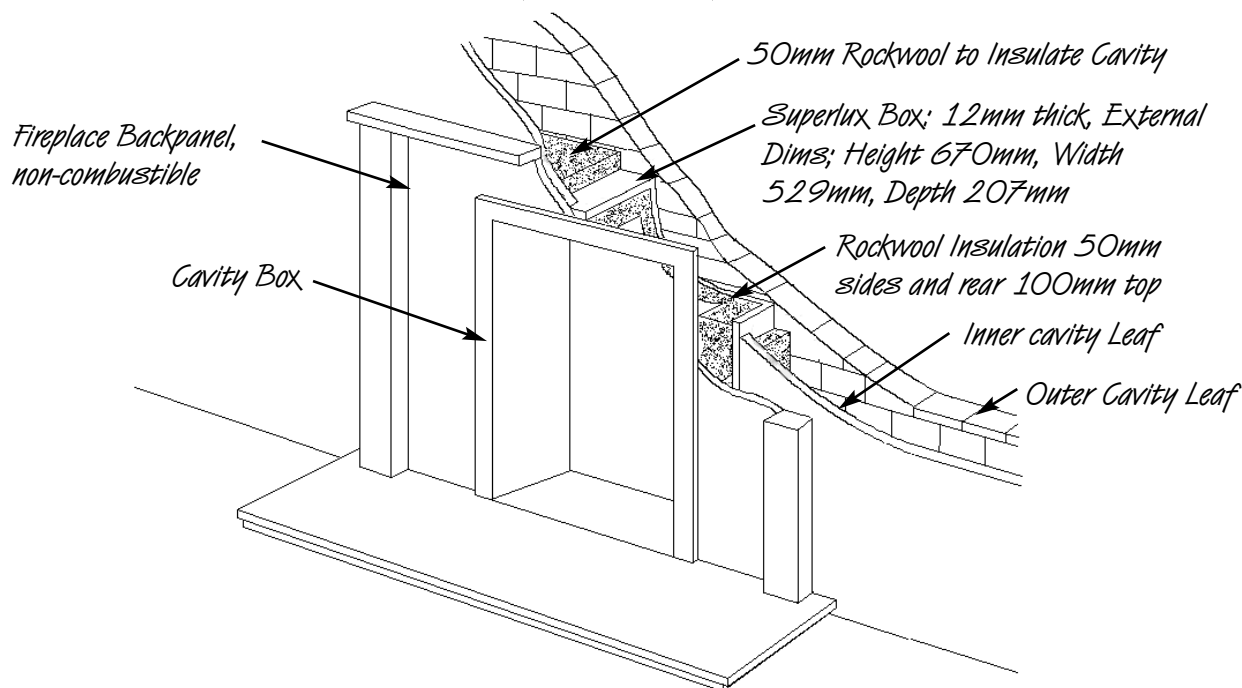

Installation as per method 2 (recessing into a wall)

When setting the appliance into the wall find a suitable position between frame timbers and open up the hole. Secure back the damp proof membrane to prevent ingress of damp.

Again 50mm insulation plus a 12 mm thick fire retardant board, 'Superlux' or equivalent, must be provided between combustible materials and the sides and rear of the cavity box. 100 mm of insulation plus a 12 mm thick fire retardant board, 'Superlux' or equivalent, must be provided to the top of the cavity box. The exposed cavity should be sealed off using non-combustible board, ('Supalux' or equivalent), made into a 4-sided box. It is also good practice to further insulate the cavity with a 50mm layer of Rockwool outside the Superlux box. Note that the appliance should not be allowed to bridge the cavity in this installation method. It is also a good idea to enable as much airflow as possible, into and out of the area behind the fire without causing excessive heat loss from the room when the fire is off.

7.0 GAS SUPPLY

When the opening is ready for installation of the fire the gas supply can be routed via knockout holes. Examples are shown in the diagram in section 6.2.

Temporarily fit the cavity box and offer up the firebox assembly to ensure a suitable gas route can be achieved.

8.0 FINAL CAVITY BOX FITTING

If not previously carried out, insert the cavity box into the opening and mark the screw locations required for fixing. Remove the cavity box and drill the previously marked holes in the opening or constructional hearth area and fit rawl plugs.

Carefully insert the cavity box into the opening and guide the gas pipe through the sealing grommet into its final routing position and fit the restrictor inlet elbow supplied to the gas pipe. Secure the cavity box by inserting screws in the previously prepared locations.

The cavity box may also be fitted using the cable fixing kit supplied as detailed in the next section.

8.1 CABLE FIXING

When using this method for fixing, the minimum depth of the opening must be increased from 145 mm to 175 mm. This is to allow for the eyebolts and a space for the cable tensioning.

Drill four holes as shown in the diagram and fit the fibre rawlplugs. If the fireplace does not allow for the exact layout shown, the eyebolts should be fixed to give as similar a configuration as possible. Thread both tensioning cables through the holes at the top of the cavity box then through both eyelets and back through the lower holes in the cavity box.

Push the cavity box back into the fireplace, centralise, pull the loose cables through the holes and into the bottom of the cavity box. Thread the cable tensioners onto the cables with the nuts screwed down close to the tensioner head. Slide the screwed nipple onto the cable, pull cable taut and tighten nipple. Adjust tensioner using a suitable spanner to pull the appliance back into position, to allow an even pull around the fireplace opening. Visually inspect and repeat if necessary to achieve a good fit.

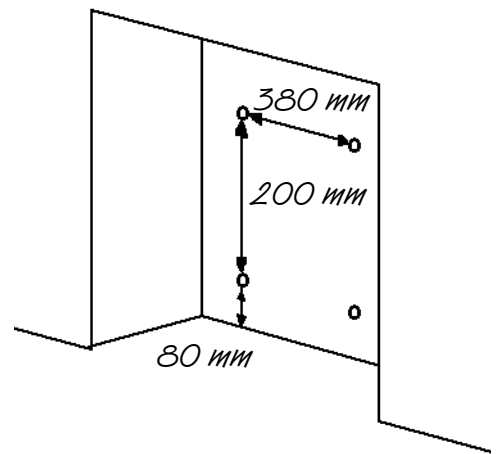

Note: Surplus cable **MUST NOT** be cut off, as this will prevent proper installation after servicing. Coil up the surplus cable and tuck the coils out of the way.

Fit the firebox assembly into the cavity box securing with the fixings originally removed. Purge the gas supply thoroughly to remove any air or grains of dirt. Now connect the restrictor elbow to the inlet pipe of the fire tray and tighten the gas connection. Pressurise the gas supply and test properly for soundness in accordance with current Approved Codes of Practice.

9.0 FUEL BED

Place the brick panel against the rear of the firebox.

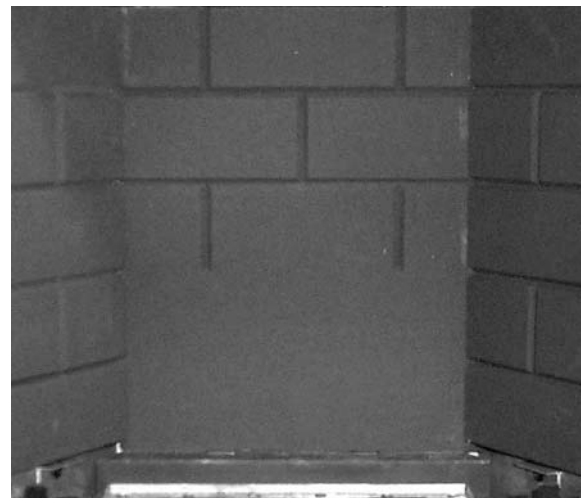

Place the ceramic combustion fuel bed onto the burner tray. Ensure that the hole for pilot flame viewing is clear and easily visible.



9.0 FUEL BED (continued)

Fit the glass door assembly with the 4 screws provide in the positions indicated. Ensure that the screws are tightened so as to achieve a good seal between the glass frame gasket and the firebox.

The fire is designed to operate correctly with the supplied components according to the instructions. Never add coals. Never put combustible or non-combustible materials, rubbish or other matter into the fire. Please note that it takes approximately 15 minutes for the full flame effect to be achieved.



10.0 FITTING THE DECORATIVE FRAME AND HOOD

The appliance is supplied with a decorative frame and hood. The frame attaches to the firebox using either four magnetic pieces, or as a three piece clip-on assembly. The side pieces of the clip on assembly should be pushed into position first, followed by the top bar, which should overlap the sides. For the single piece assembly, magnets should be fitted to the steel backing plates. A plastic protective coating may be applied to the face of the frame assembly, which should be removed at this stage.



IMPORTANT : Due to the possibility of sharp edges, care should be taken when handling the three piece frame components. The use of protective gloves is recommended.

Place the firefront into position in front of the fire and slide the ashpan door into place. Do not use any other firefront other than the one supplied with this appliance. The firefront shown in these instructions may differ from the one supplied with the appliance.



Fit the convector hood to the firebox by engaging the two mounting hooks into the relevant slots in the firebox. The hood should be pressed inwards and downwards to secure into position.

11.0 TESTING AND COMMISSIONING

As previously mentioned, firstly turn on and test the gas supply up to the fire for any leaks, in accordance with current Approved Codes of Practice (ACOPs).

11.1 OPERATING THE APPLIANCE

The pilot is visible through the left hand side of the matrix.

Push in and turn the control knob to the SPARK position, and hold there for a few seconds.

Continue turning anti-clockwise through the spark click to the PILOT light position, ensuring the pilot has lit. If not, return the knob clockwise, and repeat.



When the pilot lights after the spark, keep the knob depressed for approximately ten seconds. Now release the knob and the pilot should stay alight. If the pilot extinguishes during use, wait three minutes before repeating the ignition procedure. To achieve the HIGH setting, push the control knob in slightly and continue turning anti-clockwise to the high position. The main burner should light after a few seconds. To decrease the setting to LOW, turn the control knob clockwise to the low setting. To turn to the PILOT position from the HIGH or LOW positions, press the control knob in, and return to the pilot position and release. To turn the fire OFF, keep the knob pressed in, return to the off position and release.

11.2 SPARK FAILURE

The gap between the spark electrode and the pilot should be 3 - 5mm to produce a good spark. There should be no need to adjust this. If under any circumstances the piezo electric spark fails, the pilot cannot be lit manually.

11.3 SETTING PRESSURE

The manifold pressure test point is located either on the main injector pipe, to the left of the control plate, or on the front of the valve, which may be accessed by removing the control plate as follows;

Remove the data plate by unscrewing the two screws as shown from the front of the burner assembly.

Release the manifold pressure test point screw, situated on the left above the control knob, and attach a U gauge. Light the fire and turn to the HIGH setting.

The burner pressure should be in accordance with the figures stated in the data section of these instructions. The fire is factory set to achieve these pressures and any significant variation could indicate a supply problem. If the pressure is too high, the gas supply meter may be set incorrectly. This should be checked with the fire running and if necessary reset by the gas supplier.

If the burner pressure is too low, check the meter governor pressure with the appliance running. If this is less than 20mbar \pm 2mbar it will need to be reset by the gas supplier. If the setting pressure is too low but the meter pressure is acceptable, then a problem in the supply pipework is to be suspected. This will be dirt and debris, kinked or inadequate size pipes, restriction in a fitting, shut off elbow not fully open or solder flashing across a joint. Switch the fire off, disconnect the manometer and refit the test nipple screw. Light the fire and check for gas soundness.

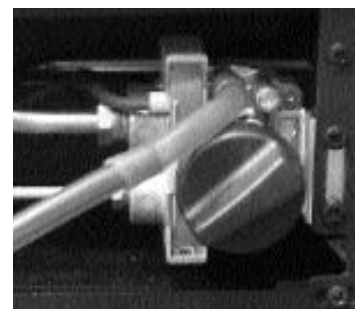
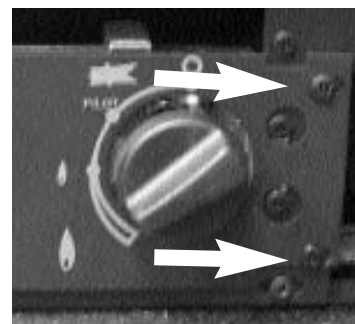

12.0 BRIEFING THE CUSTOMER

All instructions must be handed to the user for safekeeping. Show the customer how to light and control the fire. After commissioning the appliance, the customer should be instructed on the safe use of the appliance and the need for regular servicing. Frequency of service depends on usage, but MUST be carried out at least once annually. Advise that cleaning of the fire may be achieved when the fire is cold using a damp cloth and mild detergent on most surfaces. Advise that the fire will emit a "newness" smell for a time after initial commissioning and that extra ventilation may be needed during this time. Recommend that a guard be used for the protection of young children, pets, the elderly and the infirm.

13.0 SERVICING

Isolate the fire from the gas supply. Ensure that the fire is fully cold before attempting service. A suggested procedure for servicing is detailed below. For specific servicing instructions, see relevant sections.

1. Lay out the dustsheet and tools.
2. Remove the hood and front fret.
3. Remove the glass door assembly (4 screws) and clean carefully.
4. Carefully remove the ceramic components.
5. Inspect the catalyst and clean if necessary with a soft brush.
6. Disconnect the gas supply and remove the two securing screws in the tray legs.
7. Lift away burner tray assembly.
8. Strip off the burner pipes and clean thoroughly.
9. Clean the injector, pilot assembly and the burner tube. Do not attempt to remove the pilot injector.
10. Re-assemble and re-fit the burner tray.
11. Turn on the gas supply and leak test. Check pilot and burner for good ignition.
12. Refit the ceramics as per these installation instructions.
13. Refit the glass door assembly, ensuring a good seal.
14. Refit the hood.
15. Check any purpose provided ventilation is un-obstructed.
16. Light the fire and test setting pressures.
17. Check safe operation of the appliance.

13.1 CLEANING THE CERAMICS

Remove the fire front and place to one side. Remove the hood. Remove the glass door assembly. Remove the ceramic components. Gently clean in the open air with a soft brush. Be careful not to create dust from the ceramics. Where necessary replace damaged components with genuine spares. Seal scrap ceramic components in plastic bags and dispose at proper refuse sites as directed. If using a vacuum cleaner a HEPA filtering system is recommended.

Re-fit the ceramics by referring to the relevant section of these instructions. Refit the glass door assembly ensuring a good seal. Refit the hood.

13.2 SERVICING THE BURNER TRAY AND GAS ASSEMBLY

Firstly, remove the hood and front fret, the glass panel and ceramics, and disconnect the gas connection at the isolator elbow. Remove the burner tray by removing the 2 securing screws through the legs. The gas connections to the gas valve can now be released. Remove the pilot and main burner pipes and blow through to dislodge any debris. Remove the injector elbow and blow through to make sure it is entirely clear.

When replacing the injector elbow, ensure that it aligned accurately with the centre of the mixer tube entering the burner and is not at an angle. Always make sure that the nut securing the injector elbow is tight. Unclip the pilot lint gauze and clean with a soft brush. Clean the exterior of the pilot assembly with a soft brush and blow through the flame ports on the pilot head. Check the aeration holes are free from lint or dirt. The pilot assembly can be removed if required, by disconnecting the electrode lead, gas pipe and unscrewing the mounting screws and lifting away.

The pilot assembly is a non-serviceable item and should not be taken apart. Aeration holes must be absolutely clear internally for proper operation.

The gas valve is a non-serviceable item. If this needs replacement, remove the two M5 securing screws and remove the complete valve. Replacement must be done using original manufacturers parts.

Re-assembly in the reverse of removal.

13.3 PILOT ASSEMBLY

Remove the burner tray as detailed in the relevant section and pilot unit as described. Clean the pilot assembly with a soft brush and blow through. Check the aeration holes are free of any dirt or lint. Clean thoroughly internally. The connection can be removed from the base of the pilot unit using two spanners to make cleaning easier. Do not damage or try to remove the pilot injector.

The unit is factory set and the only check necessary is to ensure the spark gap is correct. See specifications for gas setting.

NEVER MODIFY OR BEND THE THERMOCOUPLE TO MAKE THE PILOT STAY ALIGHT. If the pilot will not stay lit there is a problem with dirt, the gas supply, or the thermocouple needs replacement. Modifications are dangerous and can have a serious unseen effect on safety and therefore **MUST** not be done. Replacement must be done using original manufacturers parts.

13.4 CATALYTIC CONVERTER

It is recommended that the catalytic converter is inspected for signs of damage and dirt during routine servicing procedures. The expected life of the catalyst is in excess of 11,000 hours (10 years of normal use). After this time the catalytic converter should be replaced.

If there are any deposits of dirt or soot on the catalyst they should be cleaned with a soft brush and a vacuum cleaner. If removed for cleaning ensure the seals are in good condition before replacing the catalytic converter. New seals will usually be required.

The performance of the catalyst may be checked using an analyser as follows. Any analyser used should conform to BS7927 : 1998 + A1 : 1999.

Important: The temperature of the gases emitted by the catalytic converter is in excess of 400 °C. Measuring gas of this temperature may damage some types of gas analysers. If in doubt consult the equipment manufacturer.

13.4 CATALYTIC CONVERTER (continued)

Position gas sample probe directly over the catalyst via the outlet louvre, in the centre of the upper firebox. Ignite the fire as per the operating instructions, and run at high setting for 15 minutes. Record the carbon dioxide (CO₂) concentration and then the carbon monoxide (CO) concentration as displayed by the analyser - also noting the units in which the values are expressed.

Most analysers display carbon dioxide (CO₂) concentrations in percentage (%) terms and carbon monoxide concentration in parts per million (ppm) terms.

In order to calculate the combustion ratio for the appliance (CO/CO₂) it is first necessary to express both gas concentrations in terms of percentage. To convert from parts per million (ppm) to a percentage (%) divide the ppm figure by 10,000. Examples : 35ppm = 0.0035%, 15ppm = 0.0015%, 5ppm = 0.0005%.

Now divide the concentration of carbon monoxide (CO) expressed in percent by the concentration of carbon dioxide (CO₂) to obtain the appliance combustion ratio.

$$\frac{\text{CO (\%)}}{\text{CO}_2 (\%)} = \text{ratio}$$

The combustion ratio of the gasses emitted by the catalytic convertor should not exceed 0.0015.

If replacing the catalytic converter, remove the hood and front fret, then the glass panel. The catalytic converter retaining clamp is secured with 4 nuts and slip proof washers, located on the inside of the firebox, at the top, remove these nuts and the clamp can be removed. Withdraw the clamp, followed by the catalytic converter and its seals from the firebox and discard.

Refit a new catalytic converter *and* seals in reverse order.

13.5 TESTING FOR FIREBOX LEAKAGE

Appliances that are several years old or have been extensively dismantled should be checked for soundness. It is important that all the products of combustion pass through the catalytic converter at the top of the firebox before leaving the appliance.

The firebox is heated by lighting for a few minutes to provide a flow through the firebox and catalytic converter. The burner is then shut off and a smoke pellet or match introduced at the base of the fire underneath the burner tray. Large quantities of smoke will emerge from the top of the appliance but none should emerge from around the door. It is important to note that the appliance can never be expected to be 100% smoke tight and small quantities of smoke may be seen in corners of joints and mating faces etc without affecting safety when the fire is actually in operation.

14.0 TROUBLESHOOTING GUIDE

Fire sparks but pilot does not light

No gas to fire - check isolators are open.
Pipe work blockage or kink - rectify.
Air not fully purged - re-purge supply or wait longer.
Spark earthing to metal work - check gap is correct.
Blocked pilot - check and replace where necessary.

Pilot lights but then goes out

Severe restriction in gas supply - clear obstruction.
Faulty thermocouple - replace pilot unit.
Blocked pilot - replace.
Blocked lint gauze - clean.
Hold control knob in for longer.
Check the control knob does not foul on the data plate.
If the pilot will not stay lit there is a problem with dirt, the gas supply, or the thermocouple is in need of replacement. Modifications are dangerous and can have a serious unseen effect on safety.
NEVER MODIFY OR BEND THE THERMOCOUPLE TO MAKE THE PILOT STAY ALIGHT.

Fire does not spark at pilot

Electrode lead detached - refit.
Spark gap too large or small - reset correctly.
Faulty piezo unit - replace gas valve.
Debris shorting out electrode - clean.
Spark shorting to metalwork under tray - realign electrode lead.

Fire runs for a time and then cuts off

Check pilot has extinguished.
Ensure room sizing and ventilation are adequate (See Section 3.1 and 4.1)
Loose or faulty thermocouple - rectify.
Blocked pilot - replace.
Dirt or lint in pilot aeration hole or on the lint gauze - clean thoroughly.
If the pilot will not stay lit there is a problem with dirt, the gas supply, or the thermocouple needs replacement. Modifications are dangerous and can have a serious unseen effect on safety.
NEVER MODIFY OR BEND THE THERMOCOUPLE TO MAKE THE PILOT STAY ALIGHT.

Pilot flame shrinks when fire is on high

Poor gas flow to fire - check pressure with fire on high.
If pressure is low - remove any restriction in pipework or valve.
Check all isolators are adequately sized and fully open.
Check meter pressure is adequate.
If the pilot will not stay lit there is a problem with dirt, the gas supply, or the thermocouple needs replacement. Modifications are dangerous and can have a serious unseen effect on safety.
NEVER MODIFY OR BEND THE THERMOCOUPLE TO MAKE THE PILOT STAY ALIGHT.

Fire smells when first lit or in use

Newness smell from brand new appliance. (See Preliminary Notes section)
Leakage occurring - Carry out leakage test and rectify any problems.
Low temperature sealants or combustible materials used in incorrect positions.

USER INSTRUCTIONS

<i>Section</i>	<i>Content</i>	<i>Page No</i>
1.0	Important Notes	1
2.0	Fire Front	2
3.0	Clearances to Combustibles	2
4.0	Ventilation and Room Size	2
5.0	Operating Instructions	2
6.0	Combustion Spillage Monitoring System	3
7.0	Cleaning	3
8.0	Ceramics	4
9.0	Servicing	4
10.0	List of Replacement Parts	4

1.0 IMPORTANT NOTES

The installation and Servicing of this fire **MUST** only be carried out by a competent person (such as a CORGI registered fitter) in accordance with the Gas Safety (Installation and Use) Regulations 1998, the relevant British Standards, Codes of Practice, the Building Regulations and the manufacturer's instructions.

Failure to comply with the above recommendations could lead to prosecution and invalidate the appliance warranty.

Please ensure you are handed all of the manufacturers documents on completion of the installation. This will include these instructions.

Always keep a note of the installer's name and address, the original purchase receipt and the date of installation for future reference.

The fire should be serviced regularly to ensure continued safe operation. See the servicing section of the Installation Instructions for further reference.

Parts of this appliance become naturally hot during use. It is recommended that a suitable fireguard conforming to BS 6778 or BS 6539 is used, especially where young children, pets, the elderly or infirm are concerned.

The manufacturer of this appliance considers all surfaces as working surfaces with the exception of the control knob, control panel and ash pan cover.

This appliance is intended as a secondary source of heat only, and should not be used in a room without some form of background heating present.

Combustible items, such as flooring and furniture and soft wall coverings (such as blown vinyl or embossed paper), low temperature surrounds etc may discolour if fitted too close to the fire. See relevant section for further details on clearances to combustibles. No combustible materials or flooring should protrude onto the hearth.

This appliance incorporates a safety monitoring device (Oxygen Depletion Sensor).

DO NOT burn any foreign material on this fire. The coals must be of the correct type and laid out in accordance with the relevant section of these instructions. Failure to do so may create a hazard or lead to sooting. Under no circumstances shall the appliance be used if the glass front door or panel has been removed, damaged or is open.

The integral catalytic converter should be checked by the installer upon servicing to ensure there are no defects or obstructions that may prevent the satisfactory flow of combustion products.

The expected life of the catalytic converter is in excess of 11,000 hours (10 years of normal use). After this time the catalytic converter should be replaced.

WARNING: Due to the nature of this product the area around the top of the fire (i.e. the trim) gets very hot. Care should be taken when operating the appliance.

2.0 FIREFRONT

This fire is supplied with a particular style of fire front. Use of the fire front will ensure an adequate airflow under the firebox for the correct functioning of this appliance. Compliance with safety standards cannot be guaranteed when another style of front is used.

3.0 CLEARANCES TO COMBUSTIBLES

A non-combustible shelf may be fitted to within 100mm of the top edge of the fire frame. However the items placed on it must also be able to withstand high temperatures.

A combustible shelf may be fixed to the wall above the fire, providing that it complies with the dimensions given below.

Combustible materials, such as wood, may be fitted to within 100mm (4in) of either side of the frame of the appliance, providing the forward projection does not exceed 100mm (4in).

Any combustible sidewalls must be at least 500mm to the side of the radiant heat source.

As with all heating appliances any decorations soft furnishings and wall coverings (i.e. flock, blown vinyl and embossed paper) positioned too close to the appliance may discolour or scorch.

4.0 VENTILATION AND ROOM SIZE

Purpose provided ventilation of 100cm² is required for this appliance. An openable window or louvre is also required.

Any ventilation fitted must comply with BS 5871 part 2 and BS 5440 part 2. Ventilation fitted under, or within immediate vicinity of the appliance must not be used as it may adversely effect performance of the combustion monitoring system (ODS) system.

The requirements of other appliances operating in the space or room must be taken into consideration when assessing ventilation requirements, this will have been carried out by your CORGI registered installer.

A supply of fresh air into the room is advisable to maintain temperatures within limits.

The appliance **MUST NOT** be installed in a bedroom, bathroom or any sleeping area.

For Republic of Ireland, see relevant rules in force.

The room size should be a minimum of 30m³ to allow adequate circulation of air and ensure the correct operation of the fire. This volume may include adjacent spaces, but these spaces must not be separated by a door.

5.0 OPERATING INSTRUCTIONS

The pilot is visible through the left hand side of the matrix.

Push in and turn the control knob to the SPARK position, and hold there for a few seconds.

Continue turning anti-clockwise through the spark click to the PILOT light position, ensuring the pilot has lit. If not, return the knob clockwise, and repeat.



When the pilot lights after the spark, keep the knob depressed for approximately ten seconds. Now release the knob and the pilot should stay alight. If the pilot extinguishes during use, wait three minutes before repeating the ignition procedure. To achieve the HIGH setting, push the control knob in slightly and continue turning anti-clockwise to the high position. The main burner should light after a few seconds. To decrease the setting to LOW, turn the control knob clockwise to the low setting.

To turn to the PILOT position from the HIGH or LOW positions, press the control knob in, and return to the pilot position and release. To turn the fire OFF, keep the knob pressed in, return to the off position and release.

6.0 COMBUSTION MONITORING SYSTEM

This fire is fitted with a combustion monitoring safety device (ODS). If the fire shuts down during use for no apparent reason then several reasons may be suspected. If a door or window has been opened creating a draught, then pilot disturbance could be the problem and removal of the draught should resolve this. The fire can then be re-lit in accordance with the previous section. A grommet seal may also be missing from the fire-box causing abnormal draught to shut down the pilot. Call your installer to check seals are properly fitted.

If pilot disturbance is not the cause, then the ODS safety system may be in operation. Switch the appliance OFF, call in your installer to check the appliance and ventilation. Remedial work must be carried out as required. DO NOT allow the appliance to be used until the appliance and installation is passed as safe. If the pilot continues to be extinguished you must call your installer to check the operation of the complete appliance.

<i>Maximum depth of shelf</i>	<i>Minimum distance from hearth to underside of shelf</i>
180mm	850mm
100mm	790mm

7.0 CLEANING

Before carrying out any of the following operations ensure that the fire is OFF and completely cold.

Debris that may form on the fire bed should be periodically removed by a competent person. Large deposits could indicate incorrect coal placement. This should be remedied by a competent person and the fire serviced before further use. To gain access to the fire bed, remove the hood and glass door assembly. The hood should be lifted and pulled outwards. Next remove the door by removing the 2 screws and disengaging the 2 lugs at the bottom. The glass can be cleaned using a proprietary hob cleaner. Test on a small area first.

FIREFRONT - Any dust accumulating in the fire front may be removed using a vacuum cleaner or dry cloth. Heavy stains may be removed by using a damp cloth and mild household detergent. Brass parts of the fire front may be cleaned using a suitable brass cleaner. Replace the front centrally against the fire after cleaning.

PAINTED AREAS - These can be cleaned using a dry cloth.

8.0 CERAMICS

Refer to the relevant section of the Installation section of this booklet for instructions on cleaning and replacing the ceramics.

9.0 SERVICING

The fire should be checked on an annual basis to ensure it is working safely and that there is no excessive build up of soot. The frequency of service will depend on usage but **MUST** be carried out at least once annually. Servicing must be carried out by a competent person, such as a CORGI registered installer.

Cleaning of the coals may be carried out by following the instructions given in the Installation section. The Installation instructions carry full servicing details for the use by the installer.

10.0 LIST OF SPARE PARTS

<i>PART NO.</i>	<i>ITEM</i>
FT/F780054	Ceramic combustion matrix
FB/F550085	Ceramic brick panel set
FB004225/5	Glass door assembly
FT004135/5	Convactor Hood
FT/F730023	Pilot assembly
FT003835/5	Burner tray
Please enquire	Gas valve
FB/F780052	Catalyst (seal kit must also be supplied)
FB/F940136	Seal kit for Catalyst
Please enquire	Decorative frame
Please enquire	Decorative fret

INSTALLATION INSTRUCTIONS

Preliminary Notes Before Installation

This is a High Efficiency, Flueless, Inset Live Fuel Effect appliance. It provides radiant and convected warmth both efficiently and safely utilising the latest type catalytic converter burner technology.

This fire incorporates a combustion monitoring system (Oxygen Depletion Sensor). It must not be adjusted or put out of operation. If replaced then manufacturers original parts must be used. The fire is designed to fit various types of situations as listed in the Installation Requirements.

This appliance must be installed in accordance with the rules in force and only used in a sufficiently ventilated space. *A minimum of 100cm² (15.5 in²)* purpose provided ventilation is required for this appliance, an openable window or louvre is also required. This appliance is factory set for operation on the gas type, and at the pressure stated on the appliance data plate.

The room size should be a minimum of 30m³ (1059ft³) to allow adequate circulation of air and ensure the correct operation of the fire when installed in a living room. This volume may include adjacent spaces but these spaces must not be separated by a door. In order to convert from cubic feet (ft³) to cubic metres (m³) divide the room volume (in ft³) by 35.3. This appliance is intended as a secondary source of heat only, and should not be used in a room without some form of background heating present.

The appliance must not be installed in a bedroom, bathroom or any sleeping area. The appliance does not require a flue system of any type as the catalytic converter cleans the combustion products to provide a complete combustion system which is intrinsically safe.

The appliance must be installed by a competent person in accordance with Gas Safety (Installation and Use) Regulations 1998 or rules in force. It is strongly recommended that a CORGI registered engineer is used for this purpose as they are the only persons approved by the HSE under the above regulations.

On initial lightup of a new appliance, the 'newness' smell will burn off within the first few hours of operation. During this period some smoke may be emitted from outlet louvres, this should be no cause for concern. Accordingly, the room should be well ventilated during this period.

Read all these instructions before commencing installation.

Section	Contents	Page No.	Section	Contents	Page No.
1.0	Important Notes	1	8.1	Cable Fixing	9
2.0	Appliance Data	2	9.0	Fuel Bed	9
3.0	Installation Requirements	2	10.0	Fitting Decorative Hood/Frame	10
3.1	Room Sizing	2	11.0	Testing and Commissioning	10
4.0	Site Requirements	2	11.1	Operating the Appliance	10
4.1	Ventilation	3	11.2	Spark Failure	11
5.0	Unpacking the Appliance	4	11.3	Setting Pressure	11
5.1	Component Checklist	4	12.0	Briefing the Customer	11
6.0	Appliance Installation	4	13.0	Servicing	11
6.1	Preparing the Appliance	4	13.1	Cleaning the Coals	12
6.2	Gas Supply Routes	5	13.2	Servicing the Burner Tray	12
6.3	Installation Method 1	5	13.3	Pilot Assembly	12
6.4	Installation Method 2	6	13.4	Catalytic Converter	12
6.5	Installation Method 3	7	13.5	Testing for Firebox Leakage	13
7.0	Gas Supply	8	14.0	Troubleshooting Guide	14
8.0	Final Cavity Box Fixing	8		User Instructions	

1.0 IMPORTANT NOTES

This fire is an Inset Live Fuel Gas Fire, providing radiant and convected warmth. It is designed to operate on Natural Gas following factory set adjustments, (see Data Plate on appliance for gas type and pressure).

It is the LAW that all gas appliances and fittings are installed by a competent person (such as a CORGI registered fitter) and in accordance with the Gas Safety (Installation and Use) Regulations 1998, the relevant British Standards for Installation, Codes of Practice and the Manufacturers' Instructions. The installation shall also be carried out in accordance with the following regulations:

The Building Regulations issued by the Department of the Environment, the Building Standards (Scotland) (Consolidation) Regulations issued by the Scottish Development Department.

Relevant British standards insofar as the relevant areas are not covered by these instructions.

Note: For Republic of Ireland, reference should be made to the relevant standards governing installation. (IS 813: 1996)

Failure to comply with these regulations could lead to prosecution and deem the warranty invalid.

This appliance must be installed in accordance with the rules in force and used only in a sufficiently ventilated space. A minimum of 100cm² (15.5 in²) purpose provided ventilation is required for this appliance, an openable window or louvre is also required. To reduce the possibility of draughts entering the room via the air vent, we recommend the use of "Black Hole" or "Vortex" type vents featuring internal baffles.

Consult ALL instructions before installation and use of this appliance.

This appliance is free from any asbestos material. Refractories and coal bed are constructed from ceramic fibre.

2.0

APPLIANCE DATA

Gas Group		G20 Natural Gas CAT 12H
Inlet Pressure		20 mbar
Max Energy Input		Gross 2.6 kW Net 2.35 kW
Max Gas Rate		0.25 m ³ /h
Min Energy Input		Gross 1.5 kW Net 1.35 kW
Pilot Energy Input		Gross 166 W Net 150 W
Setting Pressure	High	7.0 mbar (+/-0.25 mbar). Cold 7.5 mbar (+/-0.25 mbar). Hot
	Low	2.0 mbar (+/-0.25 mbar). Cold 2.8 mbar (+/-0.25 mbar). Hot
Main Injector Burner		Stereo. Size 60 / Bray Cat 82 - 280
Gas Inlet Connection		8 mm compression
Ignition		Piezo spark
Spark Gap		4.0 mm (± 1.0mm)
Weight		20 Kg

Please see Data Badge affixed to appliance for current data.

This appliance is for use only with the gas type, and at the pressure stated on the appliance Data Badge.

3.0

INSTALLATION REQUIREMENTS

The fire has been designed to be installed in two main applications; either to fit into a suitable opening created in the inner leaf of an outside wall or false chimney breast/extended fire surround built to conceal the appliance. The appliance can also be fitted into an unserviceable or inoperative fireplace served by a disused natural draught flue. It is recommended that the old flue should be partially sealed off to prevent draughts, however some ventilation will be required in the old flue to prevent condensation and dampness.

The cavity box and firebox must be installed onto a suitable non-combustible insulating surface at least 12 mm thick covering the entire base area of the box. The fire must be used with a back panel capable of withstanding 150°C minimum. Any combustible materials directly behind the fire frame (or back panel) and close to the cavity box of the fire must be removed and replaced with non-combustible material such as cement, browning, 'Superlux' board or equivalent materials.

3.1

ROOM SIZING

The room size should be a minimum of 30m² (e.g. 11'6" x 11'6" x 8') to allow adequate circulation of air and ensure the correct operation of the fire. To calculate a room size in cubic metres (m³) divide the room volume in cubic feet (ft³) by 35.3.

4.0

SITE REQUIREMENTS

The appliance may be installed by one of the following methods:

1. Fitment against the inner face of a house wall with a suitably constructed false chimney breast or rebated fire surround to enclose the depth of the fire. If a timber false chimney breast is constructed, clearances and insulation must be as for a timber constructed wall.
2. Insertion into a purpose made opening in the inner leaf of a cavity wall or a disused conventional fireplace opening. Bridging the cavity may cause unwanted moisture to track to the inside of the house from the cavity and therefore should be avoided. Protection from moisture and falling debris above the cavity box should be provided. If in doubt consult local building control officers.
3. Installation into a timber framed house wall using clearances and insulation as described in the appropriate section. If in doubt, consult local building control officers.

The opening dimensions for inseting the appliance must be; **WIDTH** : between 410 mm and 440 mm and **HEIGHT** : between 560 mm and 580 mm high. The opening must be within these sizes for the full depth of the cavity box in non-combustible applications. Applications involving combustible materials e.g. timber battens in false chimney breasts, must use appropriate clearances and insulation methods as described in the relevant section of these instructions.

4.0 SITE REQUIREMENTS (continued)

Opening *DEPTH* must be 145 mm or greater. Opening *DEPTH* includes any plaster, cement or infill/back panels that form part of the installation.

In the event that the fire is sited in a disused or unserviceable fireplace served by a natural draught flue, any existing under grate draught device should be sealed off to prevent loss of heat or creation of draughts. The passageway into the flue should be partially sealed to prevent excessive draughts, however some ventilation will be required in the old flue to prevent condensation and dampness. Advice should be sought from your local building control officer.

If a concealed gas connection is to be made, the supply pipe should always be sleeved through walls and floors using the shortest possible route. It is possible to install the gas supply from the side of the hearth and round into the cavity but use only factory sleeved pipe. A length of no more than 1.5m of 8mm diameter pipe must be used to avoid unnecessary pressure drops.

The wall for the opening must be non-combustible or prepared as described in the relevant section. Bare plasterboard must be protected by non-combustible plaster or replaced with non-combustible material (e.g. Superlux board). Any gap between wall boards and the wall must be filled using glass fibre insulation, silicone mastic or similar material to prevent heat ingress.

If the appliance is to be installed as a 'hole in the wall' fire it does not require any hearth as such, providing it is mounted more than 150mm (6") above floor level. NOTE: Depending on the fret and trim type supplied with the fire, a suitable non-combustible ledge for placement of the fire front will be required.

The appliance requires a hearth with a non-combustible surface of at least 12 mm thick, projecting 100mm from the front of the appliance. The top surface must be at least 50 mm above the surrounding floor level or be surrounded by a raised edge or fender 50 mm high.

Any type of fire surround used with this appliance must be adequately sealed to the wall and floor to prevent excess draughts from around the back of the fire. The temperature rating of any surround used must be 150°C minimum.

A combustible shelf may be fixed to the wall above the fire, providing that it complies with the dimensions given below.

<i>Maximum depth of shelf</i>	<i>Minimum distance from hearth to underside of shelf</i>
180mm	850mm
100mm	790mm

The shelf depth may be greater but the height must also be increased accordingly. An increase in height of 25 mm is required for every 12.5 mm of additional shelf depth. For shelves that are too low protective devices can be used such as metal heat deflectors, but it must be assured that the shelf does not reach an unacceptable temperature before relying on such a solution. A non-combustible shelf may be fitted to within 100mm of the top edge of the fire frame, but any articles placed on it must also be tolerant of high temperatures.

Combustible materials such as wood may be fitted to within 100mm (4in) of either side of the fire frame / trim, providing the forward projection does not exceed 100mm (4in). Any combustible sidewalls must be at least 500mm to the side of the radiant heat source.

As with all heating appliances any decorations, soft furnishings and wall coverings (i.e. flock, blown vinyl and embossed paper) positioned too close to the appliance may discolour or scorch.

4.1 VENTILATION

A minimum of 100 cm² purpose provided ventilation is required for this appliance. An openable window or louvre is also required. The requirements of other gas appliances operating in the same room or space must be taken into consideration when assessing ventilation.

Any ventilation fitted must comply with BS 5871 part 2 and BS 5440 part 2 insofar as the relevant areas are not covered by these instructions. Ventilation fitted under or within immediate vicinity of the appliance must not be used as it may adversely effect performance of the ODS system. The appliance **MUST NOT** be installed in a bedroom, bathroom or any sleeping area. For Republic of Ireland, see relevant rules in force.

5.0 UNPACKING THE APPLIANCE

Stand the carton the right way up, cut the strapping bands and remove the top endcap. Read ALL these instructions before continuing to unpack or install this appliance.

Remove the box containing the cast front fret, and the box containing the ceramic coals and other ceramic firebed components. Remove the cardboard packing pieces and any other bags or boxes containing fittings or other parts. When all loose parts have been removed, the outer sleeve may be lifted off to reveal the appliance. Check that the components supplied against the component checklist. Please dispose of all the packaging materials at your local recycling centre.

5.1 COMPONENT CHECKLIST

<i>QUANTITY</i>	<i>DESCRIPTION</i>
1	Cavity box, firebox and burner assembly fitted with glass panel
1	Decorative frame
1	Hood
1	Cast front fret with separate ashpan door
1	Moulded ceramic fibre combustion fuel bed
1	Ceramic pad set
1	Sealing grommet
1	Cable fixing kit
1	Screw and rawl plug pack
1	Set of manufacturers instructions and warranty card

6.0 APPLIANCE INSTALLATION

Note: Ensure that the gas supply is isolated before commencing installation of the appliance.

The fireplace opening and environment must be in compliance with specifications laid down in the appropriate sections of these instructions.

6.1 PREPARING THE APPLIANCE

Remove the appliance from its carton as described previously and stand on a dustsheet. Remove the glass panel and place it and the coals, ceramics and fixings safely to one side.

Lay the fire on its back. Remove the firebox assembly from the cavity box by removing the fixings provided on the front of the firebox frame. Place the firebox to one side for the time being.

Knock out holes are provided in the rear and sides of the cavity box for use where concealed pipework is required. Note: Knock out holes are also provided in the sides of the inner firebox if a side-entry pipe routing is required, but it is not necessary to seal these holes with grommets. Knock out the appropriate hole in the cavity box with a sharp tap from a hammer and fit the rubber grommet supplied. A small incision can now be made in the rubber to slip snugly around the outside of the supply pipe and sleeving.

Note: Do not install or use the appliance without this seal in place.

6.2 GAS SUPPLY ROUTES

The gas supply may enter the fire over the hearth or by concealed connection behind the fire.

Following preparation of the fixing method, the concealed gas supply (if required), can now be installed. When the opening is ready for installation the gas supply can be routed (examples are shown in the following diagram). If the gas pipe has been sleeved the ends of the sleeving must be sealed. The end

of the 8mm pipe should be temporarily sealed to prevent the ingress of debris during fixing. An isolator cock or or restrictor elbow must be fitted to the incoming supply to facilitate servicing.

Concealed pipes should not be routed through walls without being protected by sleeving or conduit.

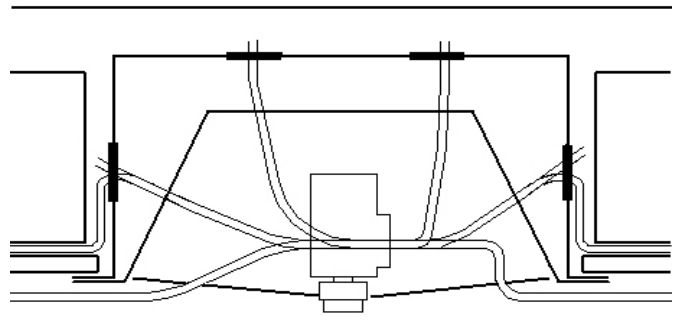

For Installation Method 1 (mounting against a wall) the supply can be routed in the normal manner. For Installation Method 2 (insetting into the inner leaf of a cavity wall) use only factory sleeved pipe in a continuous unjoined length in the cavity of the wall and areas that communicate with the cavity. This is a permitted gas supply pipe routing.

6.3 INSTALLATION METHOD 1 (against a non-combustible inside wall)

This method requires no modifications to the internal wall of a property and is achieved by using either a surround with extended rebate or a false chimney breast of minimum 145mm internal depth.

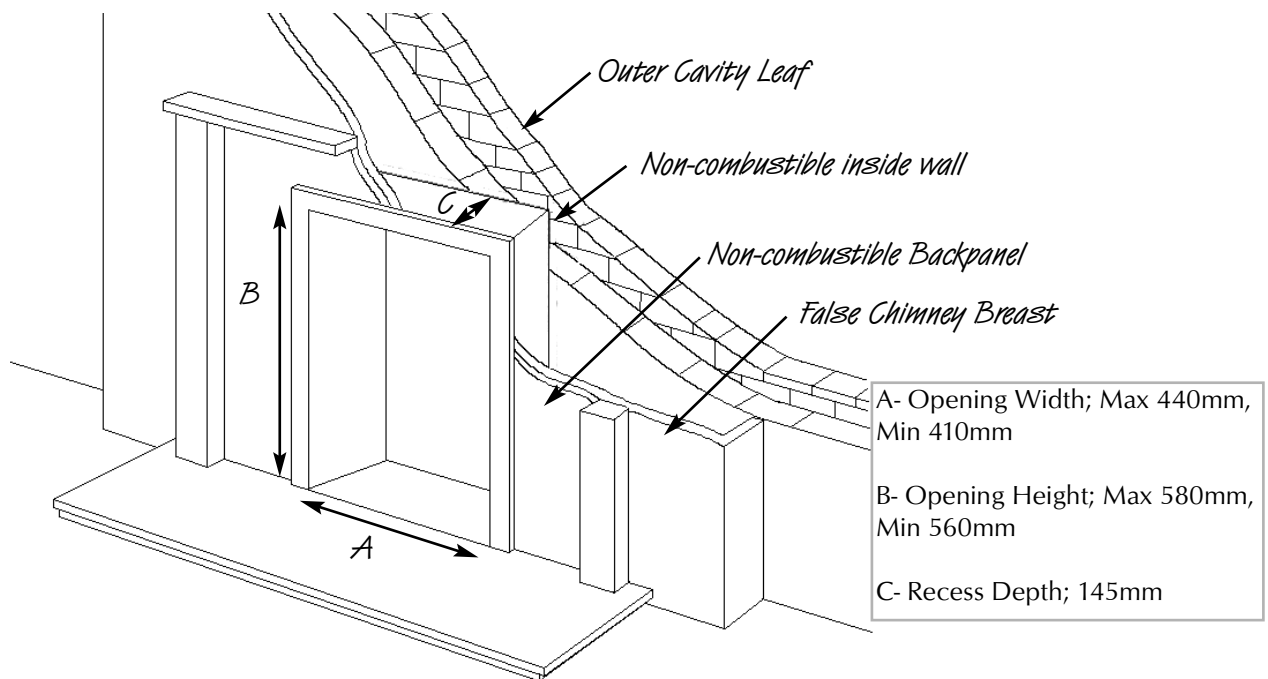

A false chimney breast should be installed, taking into account any guidance given in the section on timber framed buildings as far as insulation and clearances are concerned. As a general rule, when the false chimney breast is constructed from combustible materials the cavity box must be separated from any combustible materials by a minimum 75mm air gap at the sides and rear and 100mm air gap above the cavity box. Alternatively the cavity box may be insulated with 75mm of fibre glass wool or rock wool to the sides, rear and 100 mm to the top.

Finally install the fireplace or fire surround and back panel/marble to its finished location.

6.4 INSTALLATION METHOD 2 (recessing into a non-combustible wall)

This method allows for installation of the appliance with the rear part recessed into the inner leaf of a cavity wall. This should enable a standard fire surround and back panel/hearth set to be fitted to the wall with the fire presented naturally in a flush fitted manner. The structural integrity of the wall must be maintained.

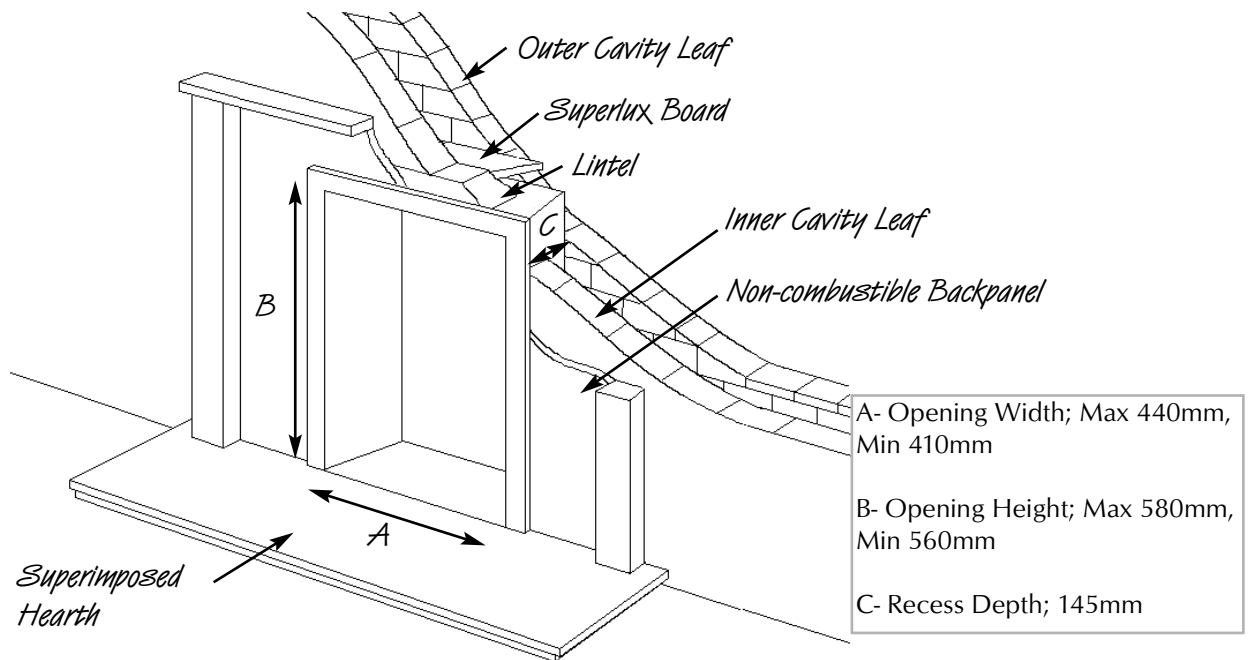

Check the cavity insulation type (if applicable). If cavity insulation is of a loose fill variety, take precautions to prevent excessive loss of material when the inner leaf is opened up by packing the cavity firmly with a minimum 50mm of rockwool or glass fibre. This will hold back any loose material now or in the future.

To maintain the structural integrity of the wall it is recommended that a suitable lintel is fitted. It is sometimes possible to install this appliance without a lintel, depending on the type of wall. The guidance of a qualified professional or local building control officer is essential to confirm this.

Mark out the area of the proposed fireplace opening on the wall. Obtain a suitable concrete or steel lintel from a builder's merchant. Drill four holes at the corners of the lintel position and squarely over the fireplace opening, and if possible centrally under a block joint. Clear out the block work in the area and insert the lintel by saw, or stitch drill and chisel. Do not dry bed the lintel - always bed on mortar and securely slate pin. Clear out the block work from below the lintel to form the opening for the cavity box of the fire to be inserted.

The top of the exposed area of cavity must be sealed against the ingress of moisture dripping from above. The best way to do this is a cavity tray but an easier and quicker method is to affix a 'Supalux' or equivalent board into the cavity. Slope the board towards the outside wall and support with screws, cement, 'Unibond' or silicone mastic etc. This will guide all moisture, harmlessly, to the outside wall. The exposed sides of the cavity must be packed with a suitable depth (minimum 50mm) of glass fibre or rock wool to prevent draughts and heat loss, even if no loose fill material is present. It is good practice to insulate the rear of the fire from the cavity to prevent heat loss and condensation.

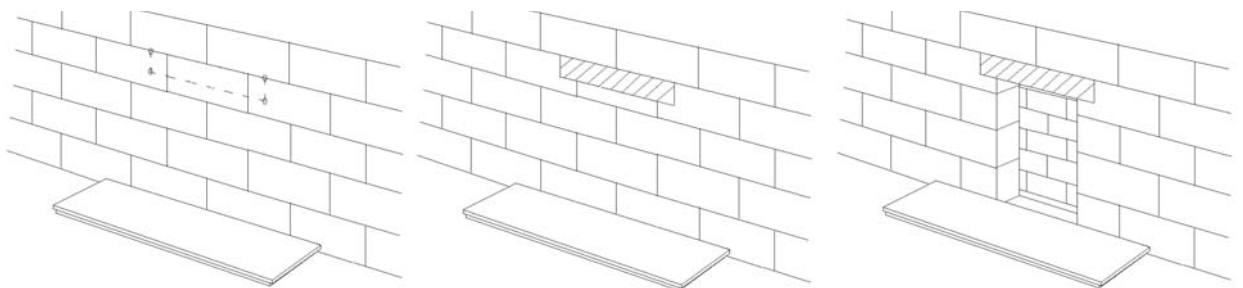

The non-combustible hearth may now be put in place. Again this should not bridge the cavity where it projects into the wall space. Finally install the fireplace or fire surround and back panel/marble to its finished location.

6.5 INSTALLATION METHOD 3 (timber framed buildings)

Where removal of any part of a timber frame is undertaken the structural integrity of the wall must be retained. The advice of your local building control officer should be sought. If the property is under any NHBC warranty it is also advised that their advice on this kind of modification is sought.

Either of the two preceding installation methods may be adapted for timber framed buildings, providing extra care is taken in ensuring combustible materials are adequately protected from the effects of heat.

The appliance must be installed in accordance with the British Gas documents DM2 and DM3 or the Institute of Gas Engineers published procedure document IGE/UP/7.

Special attention must be paid to the location of studwork frames of the inner leaf and the appliance positioned accordingly. Wires and pipes that run within the wall must also be taken into account.

Installation as per method 1 (against inner wall)

When using this method of installation the following amendments should be incorporated.

A 75mm air gap or 75mm of insulation (e.g. rockwool) must be provided between combustible materials and the sides and rear of the cavity box. A 100 mm air gap or 100mm of insulation (e.g. rockwool) must be provided to the top of the cavity box. It is also a good idea to enable as much airflow as possible, into and out of the area behind the fire without excessive heat loss from the room when the fire is off.

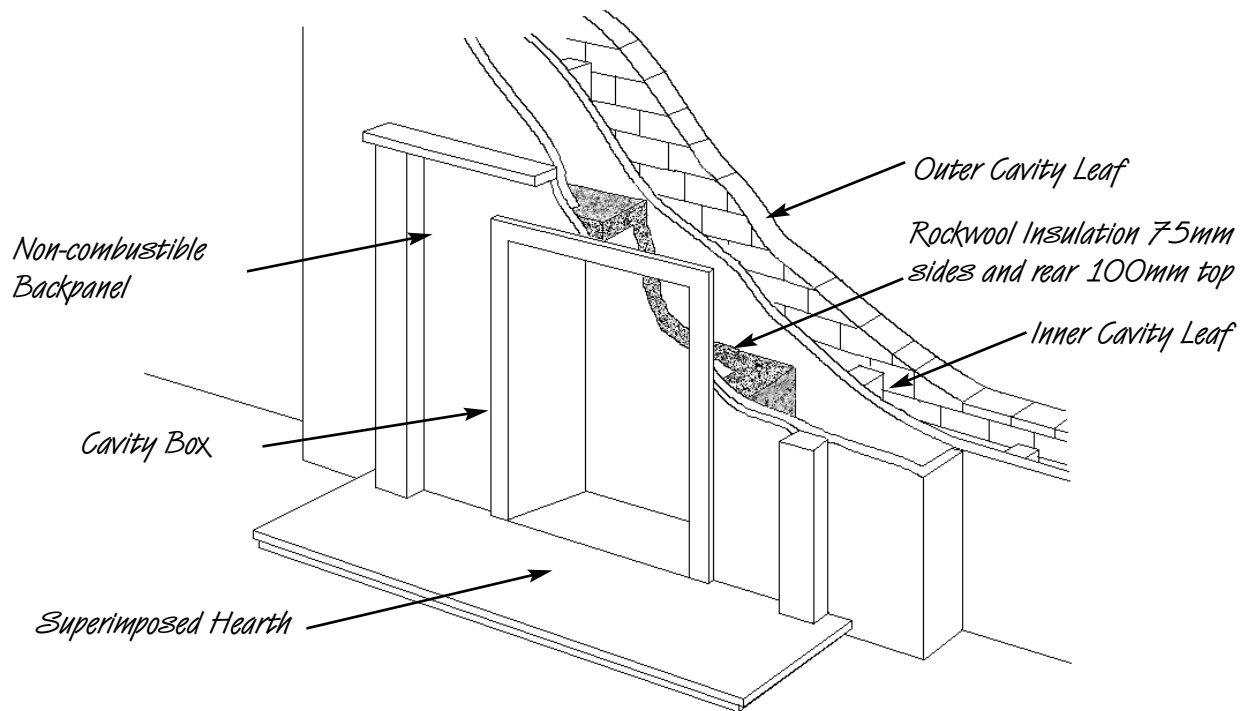

6.5 INSTALLATION METHOD 3 (continued)

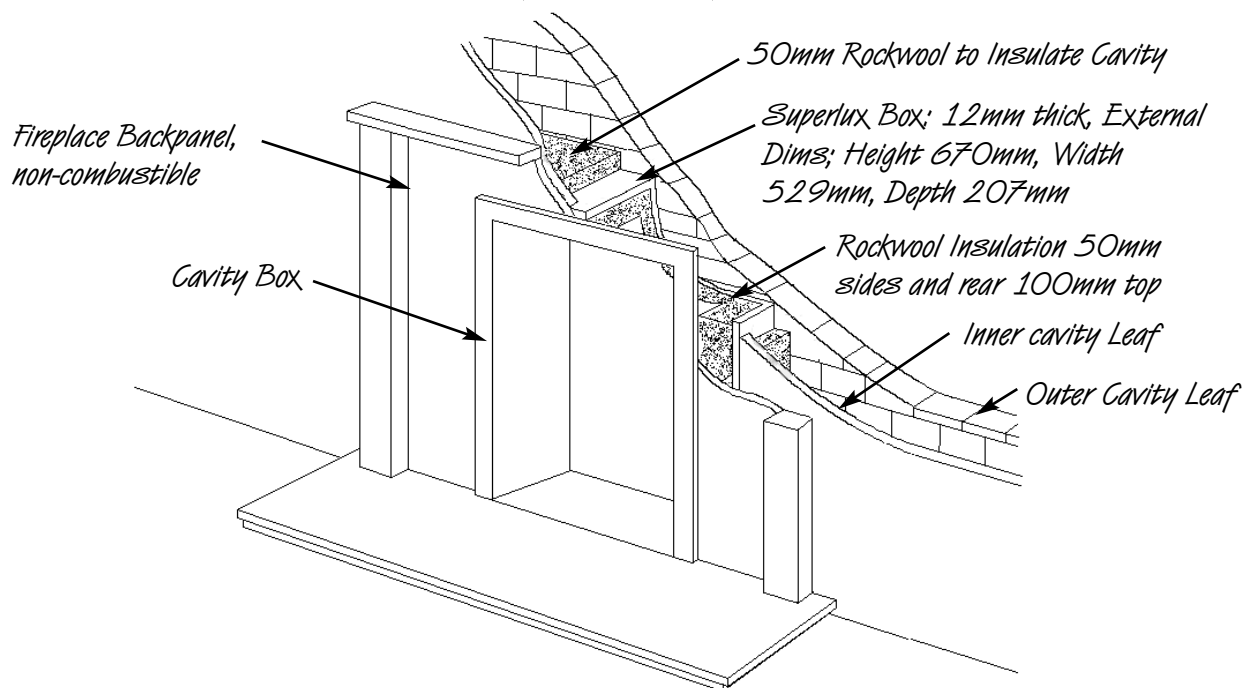

Installation as per method 2 (recessing into a wall)

When setting the appliance into the wall find a suitable position between frame timbers and open up the hole. Secure back the damp proof membrane to prevent ingress of damp.

Again 50mm insulation plus a 12 mm thick fire retardant board, 'Superlux' or equivalent, must be provided between combustible materials and the sides and rear of the cavity box. 100 mm of insulation plus a 12 mm thick fire retardant board, 'Superlux' or equivalent, must be provided to the top of the cavity box. The exposed cavity should be sealed off using non-combustible board, ('Supalux' or equivalent), made into a 4-sided box. It is also good practice to further insulate the cavity with a 50mm layer of Rockwool outside the Superlux box. Note that the appliance should not be allowed to bridge the cavity in this installation method. It is also a good idea to enable as much airflow as possible, into and out of the area behind the fire without causing excessive heat loss from the room when the fire is off.

7.0 GAS SUPPLY

When the opening is ready for installation of the fire the gas supply can be routed via knockout holes. Examples are shown in the diagram in section 6.2.

Temporarily fit the cavity box and offer up the firebox assembly to ensure a suitable gas route can be achieved.

8.0 FINAL CAVITY BOX FITTING

If not previously carried out, insert the cavity box into the opening and mark the screw locations required for fixing. Remove the cavity box and drill the previously marked holes in the opening or constructional hearth area and fit rawl plugs.

Carefully insert the cavity box into the opening and guide the gas pipe through the sealing grommet into its final routing position and fit the restrictor inlet elbow supplied to the gas pipe. Secure the cavity box by inserting screws in the previously prepared locations.

The cavity box may also be fitted using the cable fixing kit supplied as detailed in the next section.

8.1 CABLE FIXING

When using this method for fixing, the minimum depth of the opening must be increased from 145 mm to 175 mm. This is to allow for the eyebolts and a space for the cable tensioning.

Drill four holes as shown in the diagram and fit the fibre rawlplugs. If the fireplace does not allow for the exact layout shown, the eyebolts should be fixed to give as similar a configuration as possible. Thread both tensioning cables through the holes at the top of the cavity box then through both eyelets and back through the lower holes in the cavity box.

Push the cavity box back into the fireplace, centralise, pull the loose cables through the holes and into the bottom of the cavity box. Thread the cable tensioners onto the cables with the nuts screwed down close to the tensioner head. Slide the screwed nipple onto the cable, pull cable taut and tighten nipple. Adjust tensioner using a suitable spanner to pull the appliance back into position, to allow an even pull around the fireplace opening. Visually inspect and repeat if necessary to achieve a good fit.

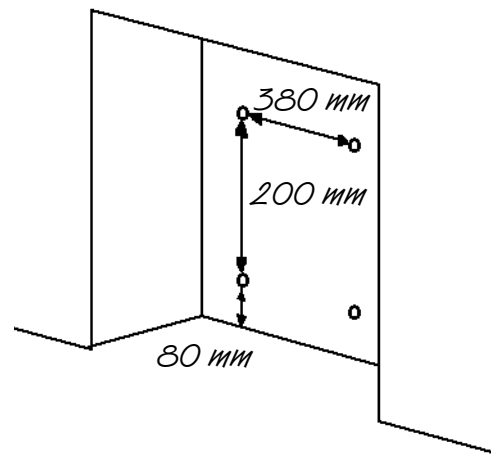

Note: Surplus cable **MUST NOT** be cut off, as this will prevent proper installation after servicing. Coil up the surplus cable and tuck the coils out of the way.

Fit the firebox assembly into the cavity box securing with the fixings originally removed. Purge the gas supply thoroughly to remove any air or grains of dirt. Now connect the restrictor elbow to the inlet pipe of the fire tray and tighten the gas connection. Pressurise the gas supply and test properly for soundness in accordance with current Approved Codes of Practice.

9.0 FUEL BED

Place the brick panel against the rear of the firebox.

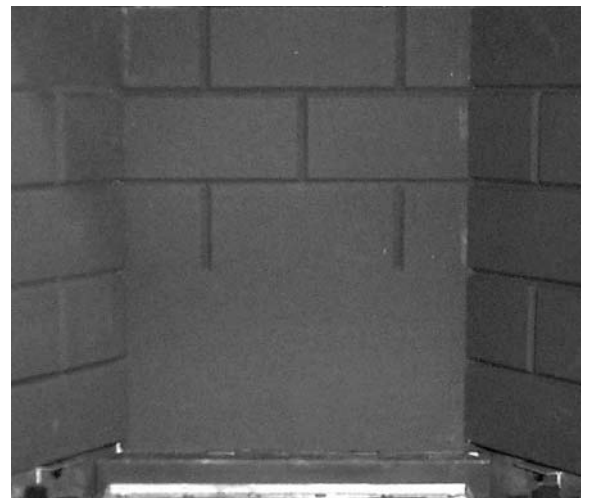

Place the ceramic combustion fuel bed onto the burner tray. Ensure that the hole for pilot flame viewing is clear and easily visible.



9.0 FUEL BED (continued)

Fit the glass door assembly with the 4 screws provide in the positions indicated. Ensure that the screws are tightened so as to achieve a good seal between the glass frame gasket and the firebox.

The fire is designed to operate correctly with the supplied components according to the instructions. Never add coals. Never put combustible or non-combustible materials, rubbish or other matter into the fire. Please note that it takes approximately 15 minutes for the full flame effect to be achieved.



10.0 FITTING THE DECORATIVE FRAME AND HOOD

The appliance is supplied with a decorative frame and hood. The frame attaches to the firebox using either four magnetic pieces, or as a three piece clip-on assembly. The side pieces of the clip on assembly should be pushed into position first, followed by the top bar, which should overlap the sides. For the single piece assembly, magnets should be fitted to the steel backing plates. A plastic protective coating may be applied to the face of the frame assembly, which should be removed at this stage.



IMPORTANT : Due to the possibility of sharp edges, care should be taken when handling the three piece frame components. The use of protective gloves is recommended.

Place the firefront into position in front of the fire and slide the ashpan door into place. Do not use any other firefront other than the one supplied with this appliance. The firefront shown in these instructions may differ from the one supplied with the appliance.



Fit the convector hood to the firebox by engaging the two mounting hooks into the relevant slots in the firebox. The hood should be pressed inwards and downwards to secure into position.

11.0 TESTING AND COMMISSIONING

As previously mentioned, firstly turn on and test the gas supply up to the fire for any leaks, in accordance with current Approved Codes of Practice (ACOPs).

11.1 OPERATING THE APPLIANCE

The pilot is visible through the left hand side of the matrix.

Push in and turn the control knob to the SPARK position, and hold there for a few seconds.

Continue turning anti-clockwise through the spark click to the PILOT light position, ensuring the pilot has lit. If not, return the knob clockwise, and repeat.



When the pilot lights after the spark, keep the knob depressed for approximately ten seconds. Now release the knob and the pilot should stay alight. If the pilot extinguishes during use, wait three minutes before repeating the ignition procedure. To achieve the HIGH setting, push the control knob in slightly and continue turning anti-clockwise to the high position. The main burner should light after a few seconds. To decrease the setting to LOW, turn the control knob clockwise to the low setting. To turn to the PILOT position from the HIGH or LOW positions, press the control knob in, and return to the pilot position and release. To turn the fire OFF, keep the knob pressed in, return to the off position and release.

11.2 SPARK FAILURE

The gap between the spark electrode and the pilot should be 3 - 5mm to produce a good spark. There should be no need to adjust this. If under any circumstances the piezo electric spark fails, the pilot cannot be lit manually.

11.3 SETTING PRESSURE

The manifold pressure test point is located either on the main injector pipe, to the left of the control plate, or on the front of the valve, which may be accessed by removing the control plate as follows;

Remove the data plate by unscrewing the two screws as shown from the front of the burner assembly.

Release the manifold pressure test point screw, situated on the left above the control knob, and attach a U gauge. Light the fire and turn to the HIGH setting.

The burner pressure should be in accordance with the figures stated in the data section of these instructions. The fire is factory set to achieve these pressures and any significant variation could indicate a supply problem. If the pressure is too high, the gas supply meter may be set incorrectly. This should be checked with the fire running and if necessary reset by the gas supplier.

If the burner pressure is too low, check the meter governor pressure with the appliance running. If this is less than 20mbar \pm 2mbar it will need to be reset by the gas supplier. If the setting pressure is too low but the meter pressure is acceptable, then a problem in the supply pipework is to be suspected. This will be dirt and debris, kinked or inadequate size pipes, restriction in a fitting, shut off elbow not fully open or solder flashing across a joint. Switch the fire off, disconnect the manometer and refit the test nipple screw. Light the fire and check for gas soundness.

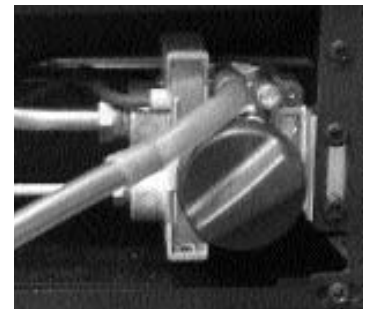
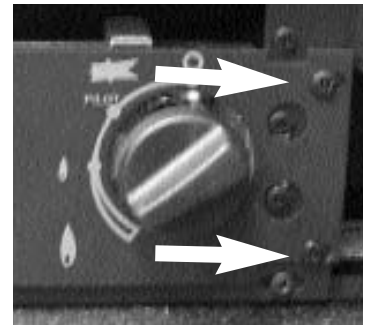

12.0 BRIEFING THE CUSTOMER

All instructions must be handed to the user for safekeeping. Show the customer how to light and control the fire. After commissioning the appliance, the customer should be instructed on the safe use of the appliance and the need for regular servicing. Frequency of service depends on usage, but MUST be carried out at least once annually. Advise that cleaning of the fire may be achieved when the fire is cold using a damp cloth and mild detergent on most surfaces. Advise that the fire will emit a "newness" smell for a time after initial commissioning and that extra ventilation may be needed during this time. Recommend that a guard be used for the protection of young children, pets, the elderly and the infirm.

13.0 SERVICING

Isolate the fire from the gas supply. Ensure that the fire is fully cold before attempting service. A suggested procedure for servicing is detailed below. For specific servicing instructions, see relevant sections.

1. Lay out the dustsheet and tools.
2. Remove the hood and front fret.
3. Remove the glass door assembly (4 screws) and clean carefully.
4. Carefully remove the ceramic components.
5. Inspect the catalyst and clean if necessary with a soft brush.
6. Disconnect the gas supply and remove the two securing screws in the tray legs.
7. Lift away burner tray assembly.
8. Strip off the burner pipes and clean thoroughly.
9. Clean the injector, pilot assembly and the burner tube. Do not attempt to remove the pilot injector.
10. Re-assemble and re-fit the burner tray.
11. Turn on the gas supply and leak test. Check pilot and burner for good ignition.
12. Refit the ceramics as per these installation instructions.
13. Refit the glass door assembly, ensuring a good seal.
14. Refit the hood.
15. Check any purpose provided ventilation is un-obstructed.
16. Light the fire and test setting pressures.
17. Check safe operation of the appliance.

13.1 CLEANING THE CERAMICS

Remove the fire front and place to one side. Remove the hood. Remove the glass door assembly. Remove the ceramic components. Gently clean in the open air with a soft brush. Be careful not to create dust from the ceramics. Where necessary replace damaged components with genuine spares. Seal scrap ceramic components in plastic bags and dispose at proper refuse sites as directed. If using a vacuum cleaner a HEPA filtering system is recommended.

Re-fit the ceramics by referring to the relevant section of these instructions. Refit the glass door assembly ensuring a good seal. Refit the hood.

13.2 SERVICING THE BURNER TRAY AND GAS ASSEMBLY

Firstly, remove the hood and front fret, the glass panel and ceramics, and disconnect the gas connection at the isolator elbow. Remove the burner tray by removing the 2 securing screws through the legs. The gas connections to the gas valve can now be released. Remove the pilot and main burner pipes and blow through to dislodge any debris. Remove the injector elbow and blow through to make sure it is entirely clear.

When replacing the injector elbow, ensure that it aligned accurately with the centre of the mixer tube entering the burner and is not at an angle. Always make sure that the nut securing the injector elbow is tight. Unclip the pilot lint gauze and clean with a soft brush. Clean the exterior of the pilot assembly with a soft brush and blow through the flame ports on the pilot head. Check the aeration holes are free from lint or dirt. The pilot assembly can be removed if required, by disconnecting the electrode lead, gas pipe and unscrewing the mounting screws and lifting away.

The pilot assembly is a non-serviceable item and should not be taken apart. Aeration holes must be absolutely clear internally for proper operation.

The gas valve is a non-serviceable item. If this needs replacement, remove the two M5 securing screws and remove the complete valve. Replacement must be done using original manufacturers parts.

Re-assembly in the reverse of removal.

13.3 PILOT ASSEMBLY

Remove the burner tray as detailed in the relevant section and pilot unit as described. Clean the pilot assembly with a soft brush and blow through. Check the aeration holes are free of any dirt or lint. Clean thoroughly internally. The connection can be removed from the base of the pilot unit using two spanners to make cleaning easier. Do not damage or try to remove the pilot injector.

The unit is factory set and the only check necessary is to ensure the spark gap is correct. See specifications for gas setting.

NEVER MODIFY OR BEND THE THERMOCOUPLE TO MAKE THE PILOT STAY ALIGHT. If the pilot will not stay lit there is a problem with dirt, the gas supply, or the thermocouple needs replacement. Modifications are dangerous and can have a serious unseen effect on safety and therefore **MUST** not be done. Replacement must be done using original manufacturers parts.

13.4 CATALYTIC CONVERTER

It is recommended that the catalytic converter is inspected for signs of damage and dirt during routine servicing procedures. The expected life of the catalyst is in excess of 11,000 hours (10 years of normal use). After this time the catalytic converter should be replaced.

If there are any deposits of dirt or soot on the catalyst they should be cleaned with a soft brush and a vacuum cleaner. If removed for cleaning ensure the seals are in good condition before replacing the catalytic converter. New seals will usually be required.

The performance of the catalyst may be checked using an analyser as follows. Any analyser used should conform to BS7927 : 1998 + A1 : 1999.

Important: The temperature of the gases emitted by the catalytic converter is in excess of 400 °C. Measuring gas of this temperature may damage some types of gas analysers. If in doubt consult the equipment manufacturer.

13.4 CATALYTIC CONVERTER (continued)

Position gas sample probe directly over the catalyst via the outlet louvre, in the centre of the upper firebox. Ignite the fire as per the operating instructions, and run at high setting for 15 minutes. Record the carbon dioxide (CO₂) concentration and then the carbon monoxide (CO) concentration as displayed by the analyser - also noting the units in which the values are expressed.

Most analysers display carbon dioxide (CO₂) concentrations in percentage (%) terms and carbon monoxide concentration in parts per million (ppm) terms.

In order to calculate the combustion ratio for the appliance (CO/CO₂) it is first necessary to express both gas concentrations in terms of percentage. To convert from parts per million (ppm) to a percentage (%) divide the ppm figure by 10,000. Examples : 35ppm = 0.0035%, 15ppm = 0.0015%, 5ppm = 0.0005%.

Now divide the concentration of carbon monoxide (CO) expressed in percent by the concentration of carbon dioxide (CO₂) to obtain the appliance combustion ratio.

$$\frac{\text{CO (\%)}}{\text{CO}_2 (\%)} = \text{ratio}$$

The combustion ratio of the gasses emitted by the catalytic convertor should not exceed 0.0015.

If replacing the catalytic converter, remove the hood and front fret, then the glass panel. The catalytic converter retaining clamp is secured with 4 nuts and slip proof washers, located on the inside of the firebox, at the top, remove these nuts and the clamp can be removed. Withdraw the clamp, followed by the catalytic converter and its seals from the firebox and discard.

Refit a new catalytic converter *and* seals in reverse order.

13.5 TESTING FOR FIREBOX LEAKAGE

Appliances that are several years old or have been extensively dismantled should be checked for soundness. It is important that all the products of combustion pass through the catalytic converter at the top of the firebox before leaving the appliance.

The firebox is heated by lighting for a few minutes to provide a flow through the firebox and catalytic converter. The burner is then shut off and a smoke pellet or match introduced at the base of the fire underneath the burner tray. Large quantities of smoke will emerge from the top of the appliance but none should emerge from around the door. It is important to note that the appliance can never be expected to be 100% smoke tight and small quantities of smoke may be seen in corners of joints and mating faces etc without affecting safety when the fire is actually in operation.

14.0 TROUBLESHOOTING GUIDE

Fire sparks but pilot does not light

No gas to fire - check isolators are open.
Pipe work blockage or kink - rectify.
Air not fully purged - re-purge supply or wait longer.
Spark earthing to metal work - check gap is correct.
Blocked pilot - check and replace where necessary.

Pilot lights but then goes out

Severe restriction in gas supply - clear obstruction.
Faulty thermocouple - replace pilot unit.
Blocked pilot - replace.
Blocked lint gauze - clean.
Hold control knob in for longer.
Check the control knob does not foul on the data plate.
If the pilot will not stay lit there is a problem with dirt, the gas supply, or the thermocouple is in need of replacement. Modifications are dangerous and can have a serious unseen effect on safety.
NEVER MODIFY OR BEND THE THERMOCOUPLE TO MAKE THE PILOT STAY ALIGHT.

Fire does not spark at pilot

Electrode lead detached - refit.
Spark gap too large or small - reset correctly.
Faulty piezo unit - replace gas valve.
Debris shorting out electrode - clean.
Spark shorting to metalwork under tray - realign electrode lead.

Fire runs for a time and then cuts off

Check pilot has extinguished.
Ensure room sizing and ventilation are adequate (See Section 3.1 and 4.1)
Loose or faulty thermocouple - rectify.
Blocked pilot - replace.
Dirt or lint in pilot aeration hole or on the lint gauze - clean thoroughly.
If the pilot will not stay lit there is a problem with dirt, the gas supply, or the thermocouple needs replacement. Modifications are dangerous and can have a serious unseen effect on safety.
NEVER MODIFY OR BEND THE THERMOCOUPLE TO MAKE THE PILOT STAY ALIGHT.

Pilot flame shrinks when fire is on high

Poor gas flow to fire - check pressure with fire on high.
If pressure is low - remove any restriction in pipework or valve.
Check all isolators are adequately sized and fully open.
Check meter pressure is adequate.
If the pilot will not stay lit there is a problem with dirt, the gas supply, or the thermocouple needs replacement. Modifications are dangerous and can have a serious unseen effect on safety.
NEVER MODIFY OR BEND THE THERMOCOUPLE TO MAKE THE PILOT STAY ALIGHT.

Fire smells when first lit or in use

Newness smell from brand new appliance. (See Preliminary Notes section)
Leakage occurring - Carry out leakage test and rectify any problems.
Low temperature sealants or combustible materials used in incorrect positions.

USER INSTRUCTIONS

<i>Section</i>	<i>Content</i>	<i>Page No</i>
1.0	Important Notes	1
2.0	Fire Front	2
3.0	Clearances to Combustibles	2
4.0	Ventilation and Room Size	2
5.0	Operating Instructions	2
6.0	Combustion Spillage Monitoring System	3
7.0	Cleaning	3
8.0	Ceramics	4
9.0	Servicing	4
10.0	List of Replacement Parts	4

1.0 IMPORTANT NOTES

The installation and Servicing of this fire **MUST** only be carried out by a competent person (such as a CORGI registered fitter) in accordance with the Gas Safety (Installation and Use) Regulations 1998, the relevant British Standards, Codes of Practice, the Building Regulations and the manufacturer's instructions.

Failure to comply with the above recommendations could lead to prosecution and invalidate the appliance warranty.

Please ensure you are handed all of the manufacturers documents on completion of the installation. This will include these instructions.

Always keep a note of the installer's name and address, the original purchase receipt and the date of installation for future reference.

The fire should be serviced regularly to ensure continued safe operation. See the servicing section of the Installation Instructions for further reference.

Parts of this appliance become naturally hot during use. It is recommended that a suitable fireguard conforming to BS 6778 or BS 6539 is used, especially where young children, pets, the elderly or infirm are concerned.

The manufacturer of this appliance considers all surfaces as working surfaces with the exception of the control knob, control panel and ash pan cover.

This appliance is intended as a secondary source of heat only, and should not be used in a room without some form of background heating present.

Combustible items, such as flooring and furniture and soft wall coverings (such as blown vinyl or embossed paper), low temperature surrounds etc may discolour if fitted too close to the fire. See relevant section for further details on clearances to combustibles. No combustible materials or flooring should protrude onto the hearth.

This appliance incorporates a safety monitoring device (Oxygen Depletion Sensor).

DO NOT burn any foreign material on this fire. The coals must be of the correct type and laid out in accordance with the relevant section of these instructions. Failure to do so may create a hazard or lead to sooting. Under no circumstances shall the appliance be used if the glass front door or panel has been removed, damaged or is open.

The integral catalytic converter should be checked by the installer upon servicing to ensure there are no defects or obstructions that may prevent the satisfactory flow of combustion products.

The expected life of the catalytic converter is in excess of 11,000 hours (10 years of normal use). After this time the catalytic converter should be replaced.

WARNING: Due to the nature of this product the area around the top of the fire (i.e. the trim) gets very hot. Care should be taken when operating the appliance.

2.0 FIREFRONT

This fire is supplied with a particular style of fire front. Use of the fire front will ensure an adequate airflow under the firebox for the correct functioning of this appliance. Compliance with safety standards cannot be guaranteed when another style of front is used.

3.0 CLEARANCES TO COMBUSTIBLES

A non-combustible shelf may be fitted to within 100mm of the top edge of the fire frame. However the items placed on it must also be able to withstand high temperatures.

A combustible shelf may be fixed to the wall above the fire, providing that it complies with the dimensions given below.

Combustible materials, such as wood, may be fitted to within 100mm (4in) of either side of the frame of the appliance, providing the forward projection does not exceed 100mm (4in).

Any combustible sidewalls must be at least 500mm to the side of the radiant heat source.

As with all heating appliances any decorations soft furnishings and wall coverings (i.e. flock, blown vinyl and embossed paper) positioned too close to the appliance may discolour or scorch.

4.0 VENTILATION AND ROOM SIZE

Purpose provided ventilation of 100cm² is required for this appliance. An openable window or louvre is also required.

Any ventilation fitted must comply with BS 5871 part 2 and BS 5440 part 2. Ventilation fitted under, or within immediate vicinity of the appliance must not be used as it may adversely effect performance of the combustion monitoring system (ODS) system.

The requirements of other appliances operating in the space or room must be taken into consideration when assessing ventilation requirements, this will have been carried out by your CORGI registered installer.

A supply of fresh air into the room is advisable to maintain temperatures within limits.

The appliance **MUST NOT** be installed in a bedroom, bathroom or any sleeping area.

For Republic of Ireland, see relevant rules in force.

The room size should be a minimum of 30m³ to allow adequate circulation of air and ensure the correct operation of the fire. This volume may include adjacent spaces, but these spaces must not be separated by a door.

5.0 OPERATING INSTRUCTIONS

The pilot is visible through the left hand side of the matrix.

Push in and turn the control knob to the SPARK position, and hold there for a few seconds.

Continue turning anti-clockwise through the spark click to the PILOT light position, ensuring the pilot has lit. If not, return the knob clockwise, and repeat.



When the pilot lights after the spark, keep the knob depressed for approximately ten seconds. Now release the knob and the pilot should stay alight. If the pilot extinguishes during use, wait three minutes before repeating the ignition procedure. To achieve the HIGH setting, push the control knob in slightly and continue turning anti-clockwise to the high position. The main burner should light after a few seconds. To decrease the setting to LOW, turn the control knob clockwise to the low setting.

To turn to the PILOT position from the HIGH or LOW positions, press the control knob in, and return to the pilot position and release. To turn the fire OFF, keep the knob pressed in, return to the off position and release.

6.0 COMBUSTION MONITORING SYSTEM

This fire is fitted with a combustion monitoring safety device (ODS). If the fire shuts down during use for no apparent reason then several reasons may be suspected. If a door or window has been opened creating a draught, then pilot disturbance could be the problem and removal of the draught should resolve this. The fire can then be re-lit in accordance with the previous section. A grommet seal may also be missing from the fire-box causing abnormal draught to shut down the pilot. Call your installer to check seals are properly fitted.

If pilot disturbance is not the cause, then the ODS safety system may be in operation. Switch the appliance OFF, call in your installer to check the appliance and ventilation. Remedial work must be carried out as required. DO NOT allow the appliance to be used until the appliance and installation is passed as safe. If the pilot continues to be extinguished you must call your installer to check the operation of the complete appliance.

<i>Maximum depth of shelf</i>	<i>Minimum distance from hearth to underside of shelf</i>
180mm	850mm
100mm	790mm

7.0 CLEANING

Before carrying out any of the following operations ensure that the fire is OFF and completely cold.

Debris that may form on the fire bed should be periodically removed by a competent person. Large deposits could indicate incorrect coal placement. This should be remedied by a competent person and the fire serviced before further use. To gain access to the fire bed, remove the hood and glass door assembly. The hood should be lifted and pulled outwards. Next remove the door by removing the 2 screws and disengaging the 2 lugs at the bottom. The glass can be cleaned using a proprietary hob cleaner. Test on a small area first.

FIREFRONT - Any dust accumulating in the fire front may be removed using a vacuum cleaner or dry cloth. Heavy stains may be removed by using a damp cloth and mild household detergent. Brass parts of the fire front may be cleaned using a suitable brass cleaner. Replace the front centrally against the fire after cleaning.

PAINTED AREAS - These can be cleaned using a dry cloth.

8.0 CERAMICS

Refer to the relevant section of the Installation section of this booklet for instructions on cleaning and replacing the ceramics.

9.0 SERVICING

The fire should be checked on an annual basis to ensure it is working safely and that there is no excessive build up of soot. The frequency of service will depend on usage but MUST be carried out at least once annually. Servicing must be carried out by a competent person, such as a CORGI registered installer.

Cleaning of the coals may be carried out by following the instructions given in the Installation section. The Installation instructions carry full servicing details for the use by the installer.

10.0 LIST OF SPARE PARTS

<i>PART NO.</i>	<i>ITEM</i>
FT/F780054	Ceramic combustion matrix
FB/F550085	Ceramic brick panel set
FB004225/5	Glass door assembly
FT004135/5	Convactor Hood
FT/F730023	Pilot assembly
FT003835/5	Burner tray
Please enquire	Gas valve
FB/F780052	Catalyst (seal kit must also be supplied)
FB/F940136	Seal kit for Catalyst
Please enquire	Decorative frame
Please enquire	Decorative fret